



STORAGE

FlexLearn cabinets

The Hohenloher FlexLearn cabinets are simply practical. In size and shape, they are perfectly matched to the teaching materials used. Our ingenious accessories can be added at any time and guarantee you a great deal of pleasure in daily use.

-  Robust construction
-  High quality materials
-  Practical accessories

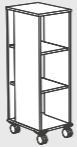
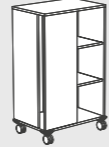
				
Name	FlexLearn cabinet 1x1	FlexLearn station 1x2	FlexLearn cabinet 3x1	FlexLearn station 3x2
Description	Carcass accessible from 3 sides with impact protection, 1 compartment	Carcass accessible from 4 sides with impact protection, 2 compartments	Carcass accessible from 3 sides with impact protection, 3 compartments	Carcass accessible from 4 sides with impact protection, 6 compartments
Versions	Carcass colour: white / oak Plinth design: Plastic glides / 4 castors, 2 of which can be locked in position	Carcass colour: white / oak Plinth design: Plastic glides / 4 castors, 2 of which can be locked in position	Carcass colour: white / oak Plinth design: Plastic glides / 4 castors, 2 of which can be locked in position	Carcass colour: white / oak Plinth design: Plastic glides / 4 castors, 2 of which can be locked in position
Options	Interior of column 1: 1 shelf / drawer panel, organisational panel (1FH): Left, right Panel colour: ME01	Interior of column 1-2: 1 shelf Organisational panel (1FH): Left, right, front, rear Panel colour: ME01	Interior of column 1: 2 shelves / drawer panel, organisational panel (3FH): Left, right Panel colour: ME01	Interior of column 1-2: 2 shelves Organisational panel (3FH): Left, right, front, rear Panel colour: ME01
Dimensions	W/H/D = 364/432/475 mm	W/H/D = 705/432/475 mm	W/H/D = 364/1130/475 mm	W/H/D = 705/1130/475 mm
Model	H1411	H1419	H1431	H1439

		
Name	FlexLearn cabinet 3x3	FlexLearn cabinet 4x4
Description	Carcass accessible from 3 sides with impact protection, 9 compartments	Carcass accessible from 3 sides with impact protection, 16 compartments
Versions	Carcass colour: white / oak Plinth design: Plastic glides / 4 castors, 2 of which can be locked in position	Carcass colour: white / oak Plinth design: Plastic glides
Options	Interior of column 1-3: 2 shelves / drawer panel, organisational panel (3FH): Left, right Panel colour: ME01	Interior of column 1-4: 3 shelves / drawer panel, organisational panel (4FH): Left, right Panel colour: ME01
Dimensions	W/H/D = 1046/1130/475 mm	W/H/D = 1387/1482/475 mm
Model	H1433	H1444

- > When using castors the total dimension increases by 52 mm
- > Height-adjustable shelves
- > Shelves suitable for FlexLearn boxes, trays, folders and FlexLearn tableau

Colour lounge

Carcass colours (HD01)



Panel colours (ME01)

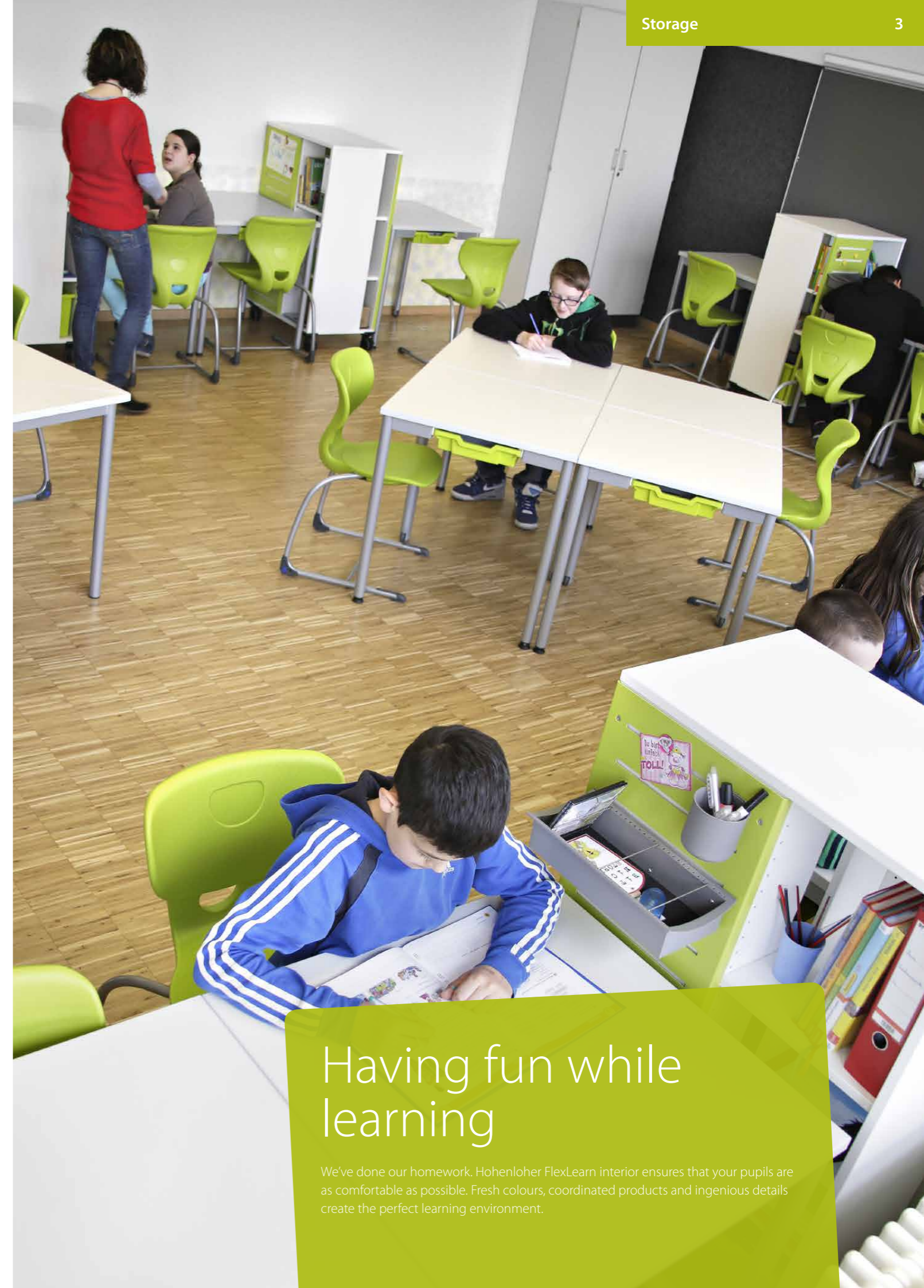





Having fun while learning

We've done our homework. Hohenloher FlexLearn interior ensures that your pupils are as comfortable as possible. Fresh colours, coordinated products and ingenious details create the perfect learning environment.

FlexLearn cabinet accessories



				
Name	FlexLearn box 75	FlexLearn box 150	FlexLearn box 225	FlexLearn box 300
Description	Material PP, can be stacked	Material PP, can be stacked	Material PP, can be stacked	Material PP, can be stacked
Versions	Colour: KU22	Colour: KU22	Colour: KU22	Colour: KU22
Dimensions	W/H/D = 312/75/427 mm	W/H/D = 312/150/427 mm	W/H/D = 312/225/427 mm	W/H/D = 312/300/427 mm
Model	8030	8032	8033	8034

				
Name	FlexLearn box cover	FlexLearn box insert	FlexLearn box label field	Tray
Description	Material PP Colour: translucent	Material PS Colour: light grey	10x, self-adhesive Colour: transparent	Plastic tray DIN A4 Colour: translucent
Dimensions	W/D = 315/430 mm	W/H/D = 275/40/388 mm	W/H = 144/37 mm	W/H/D = 270/60/340 mm
Model	8035	8036	8037	1486

Colours (KU22)



Colour lounge

Panel colours + housing colours (ME01)



Shelf colours (HD01)



				
Name	Organisational panel	Shelf	Drawer panel	Deposit box
Description	Powder-coated steel plate, d = 2 mm, magnetic, multi-slot for accessories	Wood effect board d = 19 mm, 2 mm edge on all sides, including shelf clips	Powder-coated steel plate, d = 1.5 mm, 12 drawer runners for FlexLearn box	Powder-coated steel plate, slide-in slanted shelf, with cylinder lock
Versions	Panel colour: ME01 Panel height: 1FH / 3FH / 4FH	Colour: white / oak	Panel colour: ME01 Panel height: 1FH / 3FH / 4FH	Housing colour: ME01
Dimensions	W = 365 mm	W/H/D = 322/19/433 mm	W = 358 mm	W/H/D = 315/320/435 mm
Model	H1480	H1410	H1489	H1491

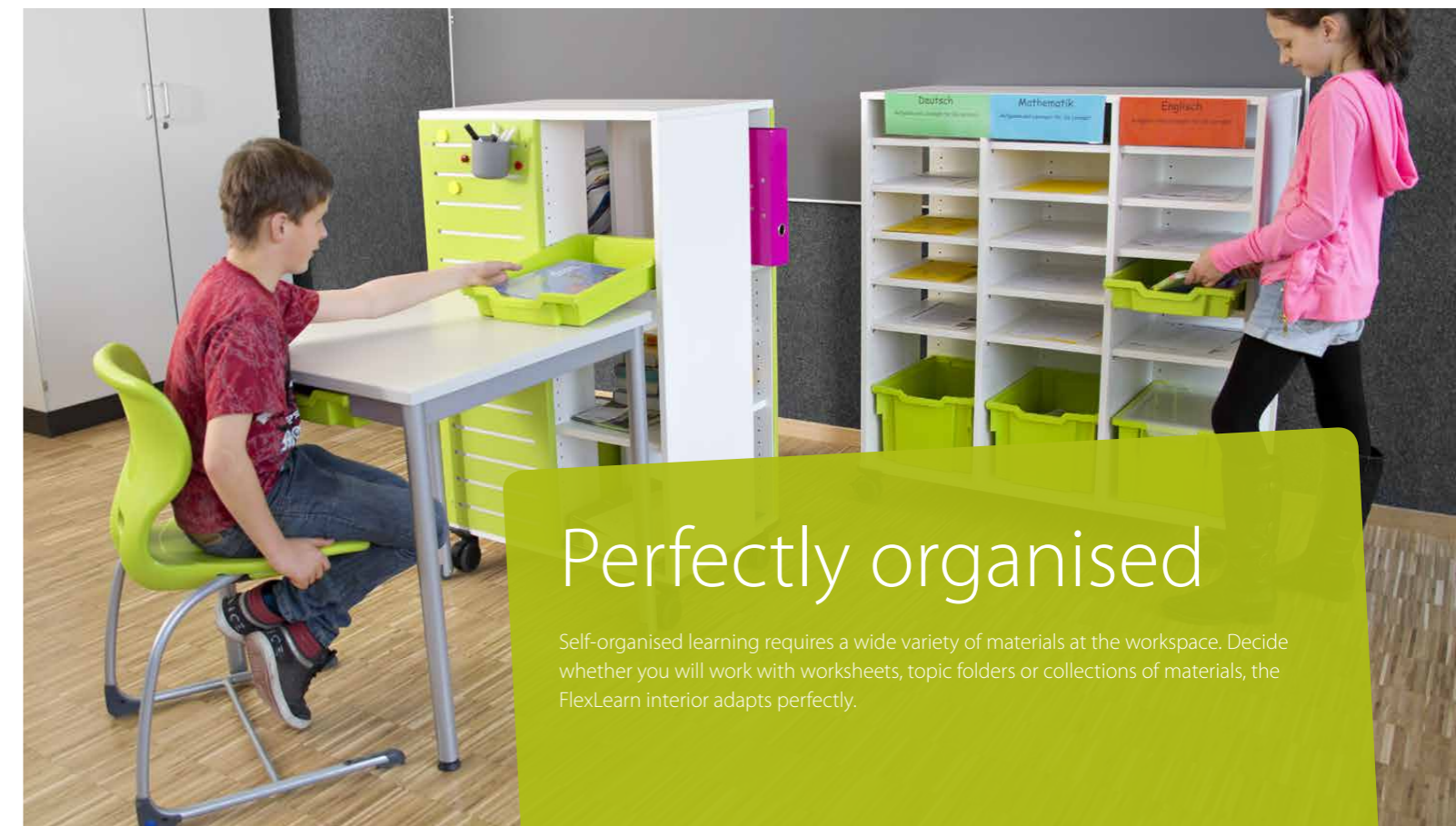

Perfectly organised

Self-organised learning requires a wide variety of materials at the workspace. Decide whether you will work with worksheets, topic folders or collections of materials, the FlexLearn interior adapts perfectly.

FlexLearn shelves

Be inspired. Our shelving systems are perfectly equipped for your collection of books, magazines and media. The RATIO FlexLearn shelving unit impresses with its simple, solid side panels made of melamine resin-coated chipboard and colourful steel shelves. Things are the other way round for the QUADRA FlexLearn shelving unit. The side sections are made of square steel tube and are complemented by shelves made of melamine resin-coated chipboard.

- + High load-bearing capacity
- + Timeless design
- + TÜV-certified quality



RATIO FlexLearn shelving unit

H5 (5x folder height / standard interior: 6 shelves)

				
Name	RATIO basic shelving unit, 1-sided	RATIO add-on shelving unit, 1-sided	RATIO basic shelving unit, 2-sided	RATIO add-on shelving unit, 2-sided
Description	Side panels made of 25 mm coated chipboard, row of holes inside, adjustable feet	Side panel made of 25 mm coated chipboard, row of holes inside, adjustable feet	Side panels made of 25 mm coated chipboard, row of holes inside, adjustable feet	Side panel made of 25 mm coated chipboard, row of holes inside, adjustable feet
Versions	Side panel colour: HD22 Delivery type: dismantled	Side panel colour: HD22 Delivery type: dismantled	Side panel colour: HD22 Delivery type: dismantled	Side panel colour: HD22 Delivery type: dismantled
Dimensions	W/H/D = 900/2056/337 mm	W/H/D = 900/2056/337 mm	W/H/D = 900/2056/640 mm	W/H/D = 900/2056/640 mm
Model	3030	3031	3032	3033

H4 (4x folder height / standard interior: 5 shelves)

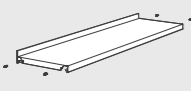
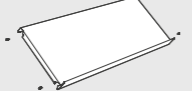
				
Name	RATIO basic shelving unit, 1-sided	RATIO add-on shelving unit, 1-sided	RATIO basic shelving unit, 2-sided	RATIO add-on shelving unit, 2-sided
Description	Side panels made of 25 mm coated chipboard, row of holes inside, adjustable feet	Side panel made of 25 mm coated chipboard, row of holes inside, adjustable feet	Side panels made of 25 mm coated chipboard, row of holes inside, adjustable feet	Side panel made of 25 mm coated chipboard, row of holes inside, adjustable feet
Versions	Side panel colour: HD22 Delivery type: dismantled	Side panel colour: HD22 Delivery type: dismantled	Side panel colour: HD22 Delivery type: dismantled	Side panel colour: HD22 Delivery type: dismantled
Dimensions	W/H/D = 900/1768/337 mm	W/H/D = 900/1768/337 mm	W/H/D = 900/1768/640 mm	W/H/D = 900/1768/640 mm
Model	3034	3035	3036	3037

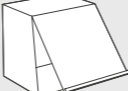
				
Name	RATIO Shelf	RATIO magazine shelf	RATIO suspended book support	RATIO magazine box
Description	Powder-coated steel plate with book rail	Powder-coated steel plate with book rail	Chrome-plated round steel bar with plastic glides	Powder-coated steel plate, slide-in slanted shelf
Versions	Metallic colour: ME22	Metallic colour: ME22		Metallic colour: ME22
Dimensions	W/D = 900/300 mm	W/D = 900/300 mm	H = 220 mm	W/H/D = 320/320/260 mm
Model	3038	3039	3040	1490



Reading inspires

Transform your library into a comfortable space. Our modern furniture system can be adapted to any room size. Whether it's a small corner with shelving or an entire library – browsing, reading and learning is a whole lot of fun here.

Colour lounge

Side panel colours (HD22)



Metallic colours (ME22)



Info

On request we are pleased to offer you other library equipment, such as counters, special shelving and a variety of accessories.

n Raum ohne Bücher
ist wie ein Körper ohne





Romane

Simply have a browse





Our FlexLearn shelves showcase your knowledge collection in the best way. To ensure that you always maintain the overview, our design experts assist you with the implementation – from taking measurements on site through to CAD drawing.

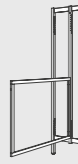

QUADRA FlexLearn shelving unit

H5 (5x folder height / standard interior: 6 shelves)

				
Name	QUADRA basic shelving unit, 1-sided	QUADRA add-on shelving unit, 1-sided	QUADRA basic shelving unit, 2-sided	QUADRA add-on shelving unit, 2-sided
Description	Side frame made of 30/30 mm powder-coated steel square tube, row of holes inside, adjustable feet	Side frame made of 30/30 mm powder-coated steel square tube, row of holes inside, adjustable feet	Side frame made of 30/30 mm powder-coated steel square tube, row of holes inside, adjustable feet	Side frame made of 30/30 mm powder-coated steel square tube, row of holes inside, adjustable feet
Versions	Frame colour: ME22 Delivery type: dismantled	Frame colour: ME22 Delivery type: dismantled	Frame colour: ME22 Delivery type: dismantled	Frame colour: ME22 Delivery type: dismantled
Dimensions	W/H/D = 900/2050/330 mm	W/H/D = 900/2050/330 mm	W/H/D = 900/2050/630 mm	W/H/D = 900/2050/630 mm
Model	3045	3046	3047	3048

H4 (4x folder height / standard interior: 5 shelves)

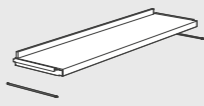
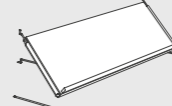
				
Name	QUADRA basic shelving unit, 1-sided	QUADRA add-on shelving unit, 1-sided	QUADRA basic shelving unit, 2-sided	QUADRA add-on shelving unit, 2-sided
Description	Side frame made of 30/30 mm powder-coated steel square tube, row of holes inside, adjustable feet	Side frame made of 30/30 mm powder-coated steel square tube, row of holes inside, adjustable feet	Side frame made of 30/30 mm powder-coated steel square tube, row of holes inside, adjustable feet	Side frame made of 30/30 mm powder-coated steel square tube, row of holes inside, adjustable feet
Versions	Frame colour: ME22 Delivery type: dismantled	Frame colour: ME22 Delivery type: dismantled	Frame colour: ME22 Delivery type: dismantled	Frame colour: ME22 Delivery type: dismantled
Dimensions	W/H/D = 900/1750/330 mm	W/H/D = 900/1750/330 mm	W/H/D = 900/1750/630 mm	W/H/D = 900/1750/630 mm
Model	3049	3050	3051	3052

				
Name	QUADRA Shelf	QUADRA magazine shelf	QUADRA suspended book support	QUADRA book support
Description	Wood effect board with book rail	Wood effect board with book rail	Chrome-plated round steel bar, can be moved	Bright galvanised round steel bar, can be inserted in the side
Versions	Wood effect colour: HD22	Wood effect colour: HD22		
Dimensions	W/D = 900/300 mm	W/D = 900/300 mm	H = 220 mm	
Model	3053	3054	3055	3056

Colour lounge

Wood effect colours (HD22)



Frame colours (ME22)



Info

On request we are pleased to offer you other library equipment, such as counters, special shelving and a variety of accessories.

Book trolley

Showcase your book collection. Display the things that are important to you! The media in your library are often small. Striking furniture creates the perfect setting and attracts the attention you want. Our book trolleys astonish with their fresh design. At the same time, they serve as a collection point for returned books and can be pushed to the shelves for sorting and putting away – truly fantastic.



Book trolley with raised partition



Ergonomic gripping for people of different height



Colour lounge

Carcass colours (HD22)

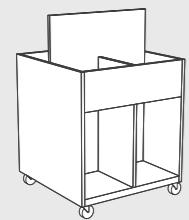
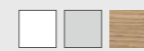

RATIO book trolley

Description	Mobile book trolley, set height at top 195 mm, at bottom 490 mm, including grooved rubber insert
Versions	Carcass colour: HD22
Dimensions	W/H/D = 720/1100/720 mm
Model	3025

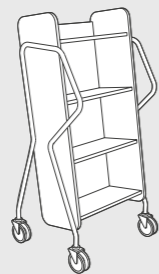

RATIO crossrunner book trolley

Description	Ergonomic book trolley with side handles
Versions	Carcass colour: HD22 H = 1220 mm (3 shelves) or 1400 mm (4 shelves)
Options	Rubber deflector rings
Dimensions	W/D = 610/540 mm
Model	3024



Lightweight and manoeuvrable

No library should be without the crossrunner book trolley. The inclined carcass ensures that the media stand safely at a user-friendly working height. The media are clearly arranged for the employee and can be easily sorted into the shelves from left to right. Aside from transporting books, the crossrunner book trolley is also perfectly suited to presenting your media.

Experiment trolley

The experiments take place here. Prepare the test arrangements on the experiment tableau and place these in the Multi-Mobile. Move the Multi-Mobile out of the garage cabinet directly to the workplaces and distribute the prepared experiments to your students. That saves valuable lesson time and adds structure to the organisation according to topic or class.

- + Compact and manoeuvrable
- + Multifunctional
- + Flexible disposition

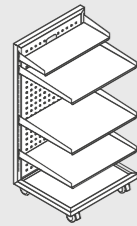
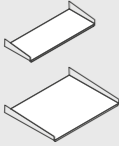

Multi-Mobile

		
Name	Multi-Mobile	Shelf
Description	Trolley fits in garage cabinet, max. 12 shelves can be suspended, hole grid on back wall of the system for mounting accessories, 4 castors, 2 of which can be locked in position Frame colour: Anthracite Rear wall- and shelf colour: Light grey RAL 7035	Shelf can be suspended in Multi-Mobile, nominal load max. 10 kg Colour: Light grey RAL 7035
Versions		Depth: 220 / 450 mm
Options	Large shelf: 1 - 12 Small shelf: 1 - 12	
Dimensions	W/H/D = 570/1120/490 mm	W/H = 555/75 mm
Model	6771	6780

Tip

Garage cabinet
Combine it with our matching garage cabinets. The Multi-Mobiles can easily be rolled in for the next use and locked up securely.

Experiment tableau
Use our custom-made experiment tableaux (Mod. 6870). These fit perfectly in the large shelves.

Device and cord trolley

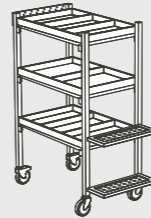

	
Device and cord trolley	
Description	Trolley for storing experiment accessories
Versions	Frame colour: Light grey
Dimensions	W/H/D = 860/1122/440 mm
Model	7027



Mobile base cabinets

U1 (for table height of 750 mm)

			
Name	Mobile cabinet U1	Mobile cabinet U1	Mobile cabinet U1
Description	1 wing door, 4 castors, 2 of which can be locked in position	2 wing doors, 4 castors, 2 of which can be locked in position	2 drawers (H = 150, 350 mm, change pull-out catch), 4 castors, 2 of which can be locked in position
Versions	Front colour: white / oak Front design: left / right	Front colour: white / oak	Front colour: white / oak
Options	Locking: single 01, 02, 03 (identical), 11 (individual) Interior: 1-2 shelf / 1-2 pull-out shelf	Locking: single 01, 02, 03 (identical), 11 (individual) Interior: 1-2 shelf / 1-2 pull-out shelf	Locking: central 01, 02, 03 (identical), 11 (individual)
Dimensions	H = 640 mm	H = 640 mm	H = 640 mm
Model	H51792 W/D = 450/550 mm H52792 W/D = 545/550 mm H52792 W/D = 600/550 mm	H53792 W/D = 845/550 mm H53792 W/D = 900/550 mm H54792 W/D = 1145/550 mm H54792 W/D = 1200/550 mm	H51791 W/D = 450/550 mm H52791 W/D = 600/550 mm H53791 W/D = 900/550 mm H54791 W/D = 1200/550 mm

			
Name	Mobile cabinet U1	Mobile cabinet U1	Mobile cabinet U1
Description	3 drawers (H = 2x 150, 1x 200 mm, change pull-out catch), 4 castors, 2 of which can be locked in position	1 drawer (H = 150 mm), 1 wing door, 4 castors, 2 of which can be locked in position	1 drawer (H = 150 mm), 2 wing doors, 4 castors, 2 of which can be locked in position
Versions	Front colour: white / oak	Front colour: white / oak Front design: left / right	Front colour: white / oak
Options	Locking: central 01, 02, 03 (identical), 11 (individual)	Locking: single 01, 02, 03 (identical), 11 (individual) Interior: 1 shelf / 1 pull-out shelf	Locking: single 01, 02, 03 (identical), 11 (individual) Interior: 1 shelf / 1 pull-out shelf
Dimensions	H = 640 mm	H = 640 mm	H = 640 mm
Model	H51794 W/D = 450/550 mm H52794 W/D = 600/550 mm H53794 W/D = 900/550 mm H54794 W/D = 1200/550 mm	H51793 W/D = 450/550 mm H52793 W/D = 600/550 mm	H53793 W/D = 900/550 mm H54793 W/D = 1200/550 mm

Colour lounge

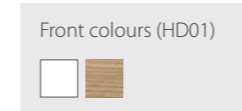

Details



Change pull-out catch





Locking



Castors

U2 (for table height of 900 mm)

			
Name	Mobile cabinet U2	Mobile cabinet U2	Mobile cabinet U2
Description	1 wing door, 4 castors, 2 of which can be locked in position	2 wing doors, 4 castors, 2 of which can be locked in position	3 drawers (H = 2x150, 1x 350 mm, change pull-out catch), 4 castors, 2 of which can be locked in position
Versions	Front colour: white / oak Front design: left / right	Front colour: white / oak	Front colour: white / oak
Options	Locking: single 01, 02, 03 (identical), 11 (individual) Interior: 1-2 shelf / 1-2 pull-out shelf	Locking: single 01, 02, 03 (identical), 11 (individual) Interior: 1-2 shelf / 1-2 pull-out shelf	Locking: central 01, 02, 03 (identical), 11 (individual)
Dimensions	H = 790 mm	H = 790 mm	H = 790 mm
Model	various widths H51692 W/D = 450/550 mm H52692 W/D = 545/550 mm H52692 W/D = 600/550 mm	H53692 W/D = 845/550 mm H53692 W/D = 900/550 mm H54692 W/D = 1145/550 mm H54692 W/D = 1200/550 mm	H51691 W/D = 450/550 mm H52691 W/D = 600/550 mm H53691 W/D = 900/550 mm H54691 W/D = 1200/550 mm



			
Name	Mobile cabinet U2	Mobile cabinet U2	Mobile cabinet U2
Description	4 drawers (H = 3x150, 1x 200 mm, change pull-out catch), 4 castors, 2 of which can be locked in position	1 drawer (H = 150 mm), 1 wing door, 4 castors, 2 of which can be locked in position	1 drawer (H = 150 mm), 2 wing doors, 4 castors, 2 of which can be locked in position
Versions	Front colour: white / oak	Front colour: white / oak Front design: left / right	Front colour: white / oak
Options	Locking: central 01, 02, 03 (identical), 11 (individual)	Locking: single 01, 02, 03 (identical), 11 (individual) Interior: 1 shelf / 1 pull-out shelf	Locking: single 01, 02, 03 (identical), 11 (individual) Interior: 1 shelf / 1 pull-out shelf
Dimensions	H = 790 mm	H = 790 mm	H = 790 mm
Model	various widths H51694 W/D = 450/550 mm H52694 W/D = 600/550 mm H53694 W/D = 900/550 mm H54694 W/D = 1200/550 mm	H51693 W/D = 450/550 mm H52693 W/D = 600/550 mm	H53693 W/D = 900/550 mm H54693 W/D = 1200/550 mm



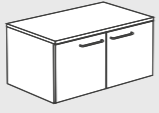

Perfect fit for C-shape

Suspended base cabinets

U1 (for table height of 750 mm)

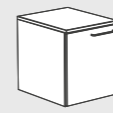
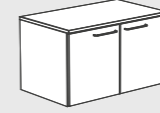

				
Name	Suspended cabinet U1	Suspended cabinet U1	Suspended cabinet U1	Suspended cabinet U1
Description	1 wing door	2 wing doors	1 drawer (H = 350 mm)	2 drawers (H = 150, 200 mm, change pull-out catch)
Versions	Front colour: white / oak Front design: left / right	Front colour: white / oak	Front colour: white / oak	Front colour: white / oak
Options	Locking: single 01, 02, 03 (identical), 11 (individual) Interior: 1-2 shelf / 1-2 pull-out shelf	Locking: single 01, 02, 03 (identical), 11 (individual) Interior: 1-2 shelf / 1-2 pull-out shelf	Locking: single 01, 02, 03 (identical), 11 (individual)	Locking: single 01, 02, 03 (identical), 11 (individual), central 01, 02, 03 (identical), 11 (individual)
Dimensions	H = 380 mm	H = 380 mm	H = 380 mm	H = 380 mm
Model	H51901 W/D = 450/550 mm	H53901 W/D = 845/550 mm	H51963 W/D = 450/550 mm	H51962 W/D = 450/550 mm
	H52901 W/D = 545/550 mm	H53901 W/D = 900/550 mm	H52963 W/D = 600/550 mm	H52962 W/D = 600/550 mm
	H52901 W/D = 600/550 mm	H54901 W/D = 1200/550 mm	H53963 W/D = 900/550 mm	H53962 W/D = 900/550 mm
			H54963 W/D = 1200/550 mm	H54962 W/D = 1200/550 mm

U2 (for table height of 900 mm)

				
Name	Suspended cabinet U2	Suspended cabinet U2	Suspended cabinet U2	Suspended cabinet U2
Description	1 wing door	2 wing doors	2 drawers (H = 150, 350 mm, change pull-out catch)	3 drawers (H = 2x 150, 1x 200 mm, change pull-out catch)
Versions	Front colour: white / oak Front design: left / right	Front colour: white / oak	Front colour: white / oak	Front colour: white / oak
Options	Locking: single 01, 02, 03 (identical), 11 (individual) Interior: 1-2 shelf / 1-2 pull-out shelf	Locking: single 01, 02, 03 (identical), 11 (individual) Interior: 1-2 shelf / 1-2 pull-out shelf	Locking: single 01, 02, 03 (identical), 11 (individual), central 01, 02, 03 (identical), 11 (individual)	Locking: single 01, 02, 03 (identical), 11 (individual), central 01, 02, 03 (identical), 11 (individual)
Dimensions	H = 530 mm	H = 530 mm	H = 530 mm	H = 530 mm
Model	H51802 W/D = 450/550 mm	H53802 W/D = 845/550 mm	H51863 W/D = 450/550 mm	H51862 W/D = 450/550 mm
	H52802 W/D = 545/550 mm	H53802 W/D = 900/550 mm	H52863 W/D = 600/550 mm	H52862 W/D = 600/550 mm
	H52802 W/D = 600/550 mm	H54802 W/D = 1200/550 mm	H53863 W/D = 900/550 mm	H53862 W/D = 900/550 mm
			H54863 W/D = 1200/550 mm	H54862 W/D = 1200/550 mm



U2 (for table height of 900 mm)

		
Name	Suspended cabinet U2	Suspended cabinet U2
Description	1 drawer (H = 150 mm) 1 wing door	1 drawer (H = 150 mm) 2 wing doors
Versions	Front colour: white / oak Front design: left / right	Front colour: white / oak
Options	Locking: single 01, 02, 03 (identical), 11 (individual) Interior: 1-2 shelf / 1-2 pull-out shelf	Locking: single 01, 02, 03 (identical), 11 (individual) Interior: 1-2 shelf / 1-2 pull-out shelf
Dimensions	H = 530 mm	H = 530 mm
Model	H51853 W/D = 450/550 mm	H53853 W/D = 900/550 mm
	H52853 W/D = 600/550 mm	H54853 W/D = 1200/550 mm

Colour lounge

Front colours (HD01)



Base cabinets

U1 (for table height of 750 mm)

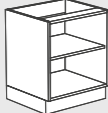
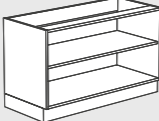
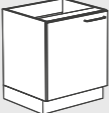
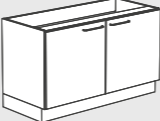



				
Name	Cabinet U1	Cabinet U1	Cabinet U1	Cabinet U1
Description	Open cupboard shelves	Open cupboard shelves	1 wing door	2 wing doors
Versions			Front colour: white / oak Front design: left / right	Front colour: white / oak
Options	Interior: 1-2 shelf / 1-2 pull-out shelf	Interior: 1-2 shelf / 1-2 pull-out shelf	Locking: single 01, 02, 03 (identical), 11 (individual) Interior: 1-2 shelf / 1-2 pull-out shelf	Locking: single 01, 02, 03 (identical), 11 (individual) Interior: 1-2 shelf / 1-2 pull-out shelf
Dimensions	H = 720 mm	H = 720 mm	H = 720 mm	H = 720 mm
Model	H51703 W/D = 450/530 mm	H53703 W/D = 900/530 mm	H51702 W/D = 450/550 mm	H53702 W/D = 900/550 mm
	H41703 W/D = 450/330 mm	H43703 W/D = 900/330 mm	H41702 W/D = 450/350 mm	H43702 W/D = 900/350 mm
	H52703 W/D = 600/530 mm	H54703 W/D = 1200/530 mm	H52702 W/D = 600/550 mm	H54702 W/D = 1200/550 mm
	H42703 W/D = 600/330 mm	H44703 W/D = 1200/330 mm	H42702 W/D = 600/350 mm	H44702 W/D = 1200/350 mm





Colour lounge

Front colours (HD01)

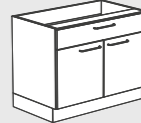

				
Name	Cabinet U1	Cabinet U1	Cabinet U1	Cabinet U1
Description	2 drawers (H = 200, 400 mm, change pull-out catch)	2 drawers (H = 200, 400 mm, change pull-out catch)	3 drawers (H = 3x 200 mm, change pull-out catch)	3 drawers (H = 3x 200 mm, change pull-out catch)
Versions	Front colour: white / oak	Front colour: white / oak	Front colour: white / oak	Front colour: white / oak
Options	Locking: single 01, 02, 03 (identical), 11 (individual), central 01, 02, 03 (identical), 11 (individual)	Locking: single 01, 02, 03 (identical), 11 (individual), central 01, 02, 03 (identical), 11 (individual)	Locking: single 01, 02, 03 (identical), 11 (individual), central 01, 02, 03 (identical), 11 (individual)	Locking: single 01, 02, 03 (identical), 11 (individual), central 01, 02, 03 (identical), 11 (individual)
Dimensions	H = 720 mm	H = 720 mm	H = 720 mm	H = 720 mm
Model	H51762 W/D = 450/550 mm	H53762 W/D = 900/550 mm	H51763 W/D = 450/550 mm	H53763 W/D = 900/550 mm
	H52762 W/D = 600/550 mm	H54762 W/D = 1200/550 mm	H52763 W/D = 600/550 mm	H54763 W/D = 1200/550 mm

				
Name	Cabinet U1	Cabinet U1	Cabinet U1	Cabinet U1
Description	4 drawers (H = 4x 150 mm, change pull-out catch)	4 drawers (H = 4x 150 mm, change pull-out catch)	1 drawer (H = 150 mm) 1 wing door	1 drawer (H = 150 mm) 2 wing doors
Versions	Front colour: white / oak	Front colour: white / oak	Front colour: white / oak Front design: left / right	Front colour: white / oak
Options	Locking: single 01, 02, 03 (identical), 11 (individual), central 01, 02, 03 (identical), 11 (individual)	Locking: single 01, 02, 03 (identical), 11 (individual), central 01, 02, 03 (identical), 11 (individual)	Locking: single 01, 02, 03 (identical), 11 (individual) Interior: 1 shelf / 1 pull-out shelf	Locking: single 01, 02, 03 (identical), 11 (individual) Interior: 1 shelf / 1 pull-out shelf
Dimensions	H = 720 mm	H = 720 mm	H = 720 mm	H = 720 mm
Model	H51764 W/D = 450/550 mm	H53764 W/D = 900/550 mm	H51753 W/D = 450/550 mm	H53753 W/D = 900/550 mm
	H52764 W/D = 600/550 mm	H54764 W/D = 1200/550 mm	H52753 W/D = 600/550 mm	H54753 W/D = 1200/550 mm

Base cabinets





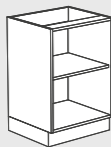
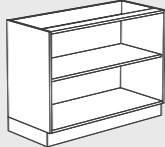
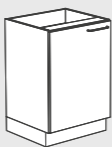
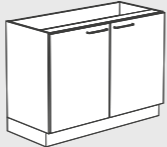

U2 (for table height of 900 mm)



				
Name	Cabinet U2	Cabinet U2	Cabinet U2	Cabinet U2
Description	Open cupboard shelves	Open cupboard shelves	1 wing door	2 wing doors
Versions			Front colour: white / oak Front design: left / right	Front colour: white / oak
Options	Interior: 1-2 shelf / 1-2 pull-out shelf	Interior: 1-2 shelf / 1-2 pull-out shelf	Locking: single 01, 02, 03 (identical), 11 (individual) Interior: 1-2 shelf / 1-2 pull-out shelf	Locking: single 01, 02, 03 (identical), 11 (individual), interior: 1-2 shelf / 1-2 pull-out shelf
Dimensions	H = 870 mm	H = 870 mm	H = 870 mm	H = 870 mm
Model	H51503 W/D = 450/530 mm	H53503 W/D = 900/530 mm	H51502 W/D = 450/550 mm	H53502 W/D = 900/550 mm
	H41503 W/D = 450/330 mm	H43503 W/D = 900/330 mm	H41502 W/D = 450/350 mm	H43502 W/D = 900/350 mm
	H52503 W/D = 600/530 mm	H54503 W/D = 1200/530 mm	H52502 W/D = 600/550 mm	H54502 W/D = 1200/550 mm
	H42503 W/D = 600/330 mm	H44503 W/D = 1200/330 mm	H42502 W/D = 600/350 mm	H44502 W/D = 1200/350 mm

Colour lounge

Front colours (HD01)



				
Name	Cabinet U2	Cabinet U2	Cabinet U2	Cabinet U2
Description	3 drawers (H = 150, 200, 400 mm, change pull-out catch)	3 drawers (H = 150, 200, 400 mm, change pull-out catch)	4 drawers (H = 1x150, 3x200 mm, change pull-out catch)	4 drawers (H = 1x150, 3x200 mm, change pull-out catch)
Versions	Front colour: white / oak	Front colour: white / oak	Front colour: white / oak	Front colour: white / oak
Options	Locking: single 01, 02, 03 (identical), 11 (individual), central 01, 02, 03 (identical), 11 (individual)	Locking: single 01, 02, 03 (identical), 11 (individual), central 01, 02, 03 (identical), 11 (individual)	Locking: single 01, 02, 03 (identical), 11 (individual), central 01, 02, 03 (identical), 11 (individual)	Locking: single 01, 02, 03 (identical), 11 (individual), central 01, 02, 03 (identical), 11 (individual)
Dimensions	H = 870 mm	H = 870 mm	H = 870 mm	H = 870 mm
Model	H51562 W/D = 450/550 mm	H53562 W/D = 900/550 mm	H51563 W/D = 450/550 mm	H53563 W/D = 900/550 mm
	H52562 W/D = 600/550 mm	H54562 W/D = 1200/550 mm	H52563 W/D = 600/550 mm	H54563 W/D = 1200/550 mm

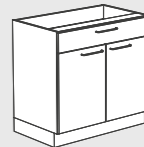

				
Name	Cabinet U2	Cabinet U2	Cabinet U2	Cabinet U2
Description	5 drawers (H = 5x 150 mm, change pull-out catch)	5 drawers (H = 5x 150 mm, change pull-out catch)	1 drawer (H = 150 mm) 1 wing door	1 drawer (H = 150 mm) 2 wing doors
Versions	Front colour: white / oak	Front colour: white / oak	Front colour: white / oak Front design: left / right	Front colour: white / oak
Options	Locking: single 01, 02, 03 (identical), 11 (individual), central 01, 02, 03 (identical), 11 (individual)	Locking: single 01, 02, 03 (identical), 11 (individual), central 01, 02, 03 (identical), 11 (individual)	Locking: single 01, 02, 03 (identical), 11 (individual) Interior: 1 shelf / 1 pull-out shelf	Locking: single 01, 02, 03 (identical), 11 (individual) Interior: 1 shelf / 1 pull-out shelf
Dimensions	H = 870 mm	H = 870 mm	H = 870 mm	H = 870 mm
Model	H51564 W/D = 450/550 mm	H53564 W/D = 900/550 mm	H51553 W/D = 450/550 mm	H53553 W/D = 900/550 mm
	H52564 W/D = 600/550 mm	H54564 W/D = 1200/550 mm	H52553 W/D = 600/550 mm	H54553 W/D = 1200/550 mm

Special base cabinets

Waste base cabinets

U1 (for table height of 750 mm)

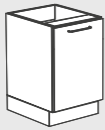
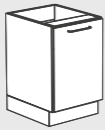
U2 (for table height of 900 mm)

				
Name	Waste cabinet U1	Waste cabinet U1	Waste cabinet U2	Waste cabinet U2
Description	1 full height drawer, incl. waste system (2x 15 litres with cover)	1 tilting door, incl. waste system (1x 30 litres without cover)	1 drawer at top (150 mm), 1 full-height drawer at bottom, incl. waste system (2x 15 litres with cover)	1 drawer at top (150 mm), 1 tilting door at bottom, incl. waste system (1x 30 litres without cover)
Versions	Front colour: white / oak	Front colour: white / oak	Front colour: white / oak	Front colour: white / oak
Dimensions	H = 720 mm	H = 720 mm	H = 870 mm	H = 870 mm
Model	H51717 W/D = 450/550 mm	H51714 W/D = 450/550 mm	H51517 W/D = 450/550 mm	H51514 W/D = 450/550 mm
	H52717 W/D = 600/550 mm	H52714 W/D = 600/550 mm	H52517 W/D = 600/550 mm	H52514 W/D = 600/550 mm

Installation base cabinets

U2 (for table height of 900 mm)

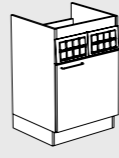
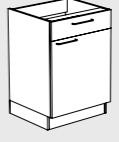
		
Name	Installation cabinet U2	Installation cabinet U2
Description	1 wing door, 2 panels	1 drawer (H = 150 mm) 1 wing door
Versions	Front colour: white Locking: single 01	Front colour: white Locking: single 01
Dimensions	W/H/D = 600/870/550 mm	W/H/D = 600/870/550 mm
Model	82S00317 door left	82S00067 door right
	82S00042 door right	

Colour lounge

Front colours (HD01)



Sink base cabinets

U2 (for table height of 900 mm)

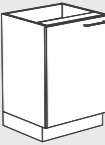
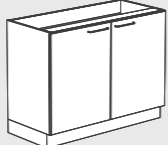
		
Name	Sink cabinet U2	Sink cabinet U2
Description	1 wing door	2 wing doors
Versions	Front colour: white / oak Front design: left / right	Front colour: white / oak
Dimensions	H = 870 mm	H = 870 mm
Model	H52596 W/D = 600/550 mm	H53596 W/D = 900/550 mm
		H54596 W/D = 1200/550 mm



Gas cylinder base cabinets

U2 (for table height of 900 mm)

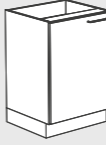
	
Name	Gas cylinder cabinet U2
Description	1 wing door, lower shelf set back with mounted aluminium plate d = 3.5 mm, without shelf
Versions	Front colour: white / oak Front design: left / right
Options	Locking: single 01, 02, 03 (identical), 11 (individual)
Dimensions	H = 870 mm
Model	H51510 W/D = 450/550 mm
	H52510 W/D = 600/550 mm



Cabinets



Colour lounge

Front colours (HD01)

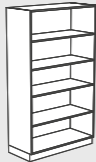

Cabinets

H5 (5x folder height - standard interior: 4 shelves)



				
Name	Cabinet H5	Cabinet H5	Cabinet H5	Cabinet H5
Description	Open cupboard shelves	Open cupboard shelves	1 wing door	2 wing doors
Versions	Cabinet type: assembled	Cabinet type: dismantled / assembled	Cabinet type: assembled Front colour: white / oak Front design: left / right	Cabinet type: dismantled / assembled Front colour: white / oak
Options	Interior: 1-5 shelf / 1-5 pull-out shelf (only with D = 550 mm)	Interior: 1-5 shelf / 1-5 pull-out shelf (only with D = 550 mm)	Locking: single 01, 02, 03 (identical), 11 (individual) Interior: 1-5 shelf / 1-5 pull-out shelf (only with D = 550 mm)	Locking: single 01, 02, 03 (identical), 11 (individual) Interior: 1-5 shelf / 1-5 pull-out shelf (only with D = 550 mm)
Dimensions	H = 2090 mm	H = 2090 mm	H = 2090 mm	H = 2090 mm
Model	H51103 W/D = 450/530 mm	H53103 W/D = 900/530 mm	H51102 W/D = 450/550 mm	H53102 W/D = 900/550 mm
	H41103 W/D = 450/330 mm	H43103 W/D = 900/330 mm	H41102 W/D = 450/350 mm	H43102 W/D = 900/350 mm
	H52103 W/D = 600/530 mm	H54104 W/D = 1200/530 mm	H52102 W/D = 600/550 mm	H54102 W/D = 1200/550 mm
	H42103 W/D = 600/330 mm	H44104 W/D = 1200/330 mm	H42102 W/D = 600/350 mm	H44102 W/D = 1200/350 mm

H5 (5x folder height - standard interior: 4 shelves)



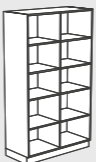

				
Name	Cabinet H5	Cabinet H5	Cabinet H5	Cabinet H5
Description	1 partially glazed wing door	2 partially glazed wing doors	1 fully glazed wing door	2 fully glazed wing doors
Versions	Cabinet type: assembled Front colour: white / oak Front design: left / right	Cabinet type: dismantled / assembled Front colour: white / oak	Cabinet type: assembled Front colour: white / oak Front design: left / right	Cabinet type: dismantled / assembled Front colour: white / oak
Options	Locking: single 01, 02, 03 (identical), 11 (individual) Interior: 1-5 shelf / 1-5 pull-out shelf (only with D = 550 mm)	Locking: single 01, 02, 03 (identical), 11 (individual) Interior: 1-5 shelf / 1-5 pull-out shelf (only with D = 550 mm)	Locking: single 01, 02, 03 (identical), 11 (individual) Interior: 1-5 shelf / 1-5 pull-out shelf (only with D = 550 mm)	Locking: single 01, 02, 03 (identical), 11 (individual) Interior: 1-5 shelf / 1-5 pull-out shelf (only with D = 550 mm)
Dimensions	H = 2090 mm	H = 2090 mm	H = 2090 mm	H = 2090 mm
Model	H51137 W/D = 450/550 mm	H53137 W/D = 900/550 mm	H51140 W/D = 450/550 mm	H53140 W/D = 900/550 mm
	H41137 W/D = 450/350 mm	H43137 W/D = 900/350 mm	H41140 W/D = 450/350 mm	H43140 W/D = 900/350 mm
	H52137 W/D = 600/550 mm	H54137 W/D = 1200/550 mm	H52140 W/D = 600/550 mm	H54140 W/D = 1200/550 mm
	H42137 W/D = 600/350 mm	H44137 W/D = 1200/350 mm	H42140 W/D = 600/350 mm	H44140 W/D = 1200/350 mm

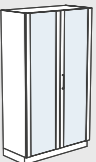
Cabinets with partition panel

H5 (5x folder height - standard interior: 4 shelves)

				
Name	Cabinet H5	Cabinet H5	Cabinet H5	Cabinet H5
Description	Open cupboard shelves, with partition panel	2 wing doors, with partition panel	2 partially glazed wing doors, with partition panel	2 fully glazed wing doors, with partition panel
Versions	Cabinet type: dismantled / assembled	Cabinet type: dismantled / assembled Front colour: white / oak	Cabinet type: dismantled / assembled Front colour: white / oak	Cabinet type: dismantled / assembled Front colour: white / oak
Options	Interior: 1-5 shelf	Locking: single 01, 02, 03 (identical), 11 (individual) Interior: 1-5 shelf	Locking: single 01, 02, 03 (identical), 11 (individual) Interior: 1-5 shelf	Locking: single 01, 02, 03 (identical), 11 (individual) Interior: 1-5 shelf
Dimensions	H = 2090 mm	H = 2090 mm	H = 2090 mm	H = 2090 mm
Model	H54105 W/D = 1200/530 mm	H54133 W/D = 1200/550 mm	H54138 W/D = 1200/550 mm	H54141 W/D = 1200/550 mm
	H44105 W/D = 1200/330 mm	H44133 W/D = 1200/350 mm	H44138 W/D = 1200/350 mm	H44141 W/D = 1200/350 mm



H3 (3x folder height - standard interior: 2 shelves)

				
Name	Cabinet H3	Cabinet H3	Cabinet H3	Cabinet H3
Description	Open cupboard shelves	Open cupboard shelves	1 wing door	2 wing doors
Versions	Cabinet type: assembled	Cabinet type: dismantled / assembled	Cabinet type: assembled Front colour: white / oak Front design: left / right	Cabinet type: dismantled / assembled Front colour: white / oak
Options	Interior: 1-3 shelf / 1-3 pull-out shelf (only with D = 550 mm)	Interior: 1-3 shelf / 1-3 pull-out shelf (only with D = 550 mm)	Locking: single 01, 02, 03 (identical), 11 (individual) Interior: 1-3 shelf / 1-3 pull-out shelf (only with D = 550 mm)	Locking: single 01, 02, 03 (identical), 11 (individual) Interior: 1-3 shelf / 1-3 pull-out shelf (only with D = 550 mm)
Dimensions	H = 1220 mm	H = 1220 mm	H = 1220 mm	H = 1220 mm
Model	H51403 W/D = 450/530 mm	H53403 W/D = 900/530 mm	H51402 W/D = 450/550 mm	H53402 W/D = 900/550 mm
	H41403 W/D = 450/330 mm	H43403 W/D = 900/330 mm	H41402 W/D = 450/350 mm	H43402 W/D = 900/350 mm
	H52403 W/D = 600/530 mm	H54403 W/D = 1200/530 mm	H52402 W/D = 600/550 mm	H54402 W/D = 1200/550 mm
	H42403 W/D = 600/330 mm	H44404 W/D = 1200/330 mm	H42402 W/D = 600/350 mm	H44402 W/D = 1200/350 mm

Drawer cabinets

Drawer cabinets

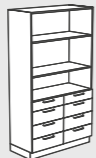
H5 (3x folder height - standard interior: 2 shelves)

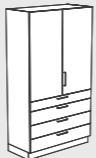

				
Name	Drawer cabinet H5	Drawer cabinet H5	Drawer cabinet H5	Drawer cabinet H5
Description	Open at top, 4 drawers at bottom	Open at top, 2x4 drawers at bottom	1 wing door above, 4 drawers at bottom	2 wing doors above, 4 drawers at bottom
Versions	Cabinet type: dismantled / assembled, front colour: white / oak	Cabinet type: dismantled / assembled, front colour: white / oak	Cabinet type: assembled, front colour: white / oak Front design: left / right	Cabinet type: dismantled / assembled, front colour: white / oak
Options	Locking: single 01, 02, 03 (identical), 11 (individual) Central 01, 02, 03 (identical), 11 (individual) Interior: 1-3 shelf / 1-3 pull-out shelf	Locking: single 01, 02, 03 (identical), 11 (individual) Central 01, 02, 03 (identical), 11 (individual) Interior: 1-3 shelf / 1-3 pull-out shelf	Locking: single 01, 02, 03 (identical), 11 (individual) Central 01, 02, 03 (identical), 11 (individual) Interior: 1-3 shelf / 1-3 pull-out shelf	Locking: single 01, 02, 03 (identical), 11 (individual) Central 01, 02, 03 (identical), 11 (individual) Interior: 1-3 shelf / 1-3 pull-out shelf
Dimensions	H = 2090 mm	H = 2090 mm	H = 2090 mm	H = 2090 mm
Model	H52151 W/D = 600/550 mm H53151 W/D = 900/550 mm H54151 W/D = 1200/550 mm	H53152 W/D = 900/550 mm H54152 W/D = 1200/550 mm	H52153 W/D = 600/550 mm	H53153 W/D = 900/550 mm H54153 W/D = 1200/550 mm

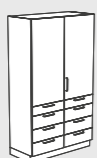
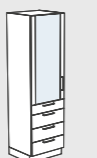
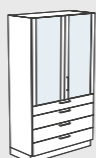
H5 (3x folder height - standard interior: 2 shelves)

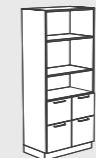

				
Name	Drawer cabinet H5	Drawer cabinet H5	Drawer cabinet H5	Drawer cabinet H5
Description	2 wing doors above, 2x4 drawers at bottom	1 fully glazed wing door at top, 4 drawers at bottom	2 fully glazed wing doors at top, 4 drawers at bottom	2 fully glazed wing doors at top, 2x4 drawers at bottom
Versions	Cabinet type: dismantled / assembled, front colour: white / oak	Cabinet type: assembled, front colour: white / oak Front design: left / right	Cabinet type: dismantled / assembled, front colour: white / oak	Cabinet type: dismantled / assembled, front colour: white / oak
Options	Locking: single 01, 02, 03 (identical), 11 (individual) Central 01, 02, 03 (identical), 11 (individual) Interior: 1-3 shelf / 1-3 pull-out shelf	Locking: single 01, 02, 03 (identical), 11 (individual) Central 01, 02, 03 (identical), 11 (individual) Interior: 1-3 shelf / 1-3 pull-out shelf	Locking: single 01, 02, 03 (identical), 11 (individual) Central 01, 02, 03 (identical), 11 (individual) Interior: 1-3 shelf / 1-3 pull-out shelf	Locking: single 01, 02, 03 (identical), 11 (individual) Central 01, 02, 03 (identical), 11 (individual) Interior: 1-3 shelf / 1-3 pull-out shelf
Dimensions	H = 2090 mm	H = 2090 mm	H = 2090 mm	H = 2090 mm
Model	H53154 W/D = 900/550 mm H54154 W/D = 1200/550 mm	H52155 W/D = 600/550 mm	H53155 W/D = 900/550 mm H54155 W/D = 1200/550 mm	H53156 W/D = 900/550 mm H54156 W/D = 1200/550 mm

Drawer cabinets with suspension file rack

H5 (3x folder height - standard interior: 2 shelves)

				
Name	Drawer cabinet H5	Drawer cabinet H5	Drawer cabinet H5	Drawer cabinet H5
Description	Open at top, 2 drawers at bottom	Open at top, 2x2 drawers at bottom	1 wing door at top, 2 drawers at bottom	2 wing doors above, 2x2 drawers at bottom
Versions	Cabinet type: assembled, front colour: white / oak	Cabinet type: dismantled / assembled, front colour: white / oak	Cabinet type: assembled, front colour: white / oak Front design: left / right	Cabinet type: dismantled / assembled, front colour: white / oak
Options	Locking: single 01, 02, 03 (identical), 11 (individual) Central 01, 02, 03 (identical), 11 (individual) Interior: 1-3 shelf / 1-3 pull-out shelf	Locking: single 01, 02, 03 (identical), 11 (individual) Central 01, 02, 03 (identical), 11 (individual) Interior: 1-3 shelf / 1-3 pull-out shelf	Locking: single 01, 02, 03 (identical), 11 (individual) Central 01, 02, 03 (identical), 11 (individual) Interior: 1-3 shelf / 1-3 pull-out shelf	Locking: single 01, 02, 03 (identical), 11 (individual) Central 01, 02, 03 (identical), 11 (individual) Interior: 1-3 shelf / 1-3 pull-out shelf
Dimensions	H = 2090 mm	H = 2090 mm	H = 2090 mm	H = 2090 mm
Model	H52157 W/D = 600/550 mm	H53157 W/D = 900/550 mm H54157 W/D = 1200/550 mm	H52158 W/D = 600/550 mm	H53158 W/D = 900/550 mm H54158 W/D = 1200/550 mm

H5 (3x folder height - standard interior: 2 shelves)

		
Name	Drawer cabinet H5	Drawer cabinet H5
Description	1 fully glazed wing door at top, 2 drawers at bottom	2 fully glazed wing doors at top, 2x2 drawers at bottom
Versions	Cabinet type: assembled, front colour: white / oak Front design: left / right	Cabinet type: dismantled / assembled, front colour: white / oak
Options	Locking: single 01, 02, 03 (identical), 11 (individual) Central 01, 02, 03 (identical), 11 (individual) Interior: 1-3 shelf / 1-3 pull-out shelf	Locking: single 01, 02, 03 (identical), 11 (individual) Central 01, 02, 03 (identical), 11 (individual) Interior: 1-3 shelf / 1-3 pull-out shelf
Dimensions	H = 2090 mm	H = 2090 mm
Model	H52159 W/D = 600/550 mm	H53159 W/D = 900/550 mm H54159 W/D = 1200/550 mm

Colour lounge

Front colours (HD01)





Info

Please order suspension file rack insert separately:
Mod. H51233

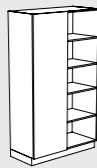

Corner cabinets

Corner cabinets

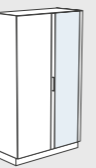
H5 Fixed panel on left (5x folder height - standard interior: 4 shelves)

				
Name	Corner cabinet H5	Corner cabinet H5	Corner cabinet H5	Corner cabinet H5
Description	1 fixed panel on left, open on right	1 fixed panel on left, 1 wing door on right	1 fixed panel on left, 1 partially glazed wing door on right	1 fixed panel on left, 1 fully glazed wing door on right
Versions	Cabinet type: assembled Front colour: white / oak	Cabinet type: assembled Front colour: white / oak	Cabinet type: assembled Front colour: white / oak	Cabinet type: assembled Front colour: white / oak
Options	Interior: 1-5 shelf	Locking: single 01, 02, 03 (identical), 11 (individual) Interior: 1-5 shelf	Locking: single 01, 02, 03 (identical), 11 (individual) Interior: 1-5 shelf	Locking: single 01, 02, 03 (identical), 11 (individual) Interior: 1-5 shelf
Dimensions	H = 2090 mm	H = 2090 mm	H = 2090 mm	H = 2090 mm
Model	H54108 W/D = 1200/550 mm H44108 W/D = 1200/350 mm	H54112 W/D = 1200/550 mm H44112 W/D = 1200/350 mm	H54109 W/D = 1200/550 mm H44109 W/D = 1200/350 mm	H54111 W/D = 1200/550 mm H44111 W/D = 1200/350 mm

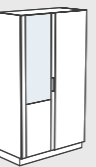
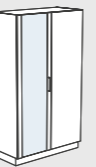

H5 Fixed panel on right (5x folder height - standard interior: 4 shelves)

				
Name	Corner cabinet H5	Corner cabinet H5	Corner cabinet H5	Corner cabinet H5
Description	1 fixed panel on right, open on left	1 fixed panel on right, 1 wing door on left	1 fixed panel on right, 1 partially glazed wing door on left	1 fixed panel on right, 1 fully glazed wing door on left
Versions	Cabinet type: assembled Front colour: white / oak	Cabinet type: assembled Front colour: white / oak	Cabinet type: assembled Front colour: white / oak	Cabinet type: assembled Front colour: white / oak
Options	Interior: 1-5 shelf	Locking: single 01, 02, 03 (identical), 11 (individual) Interior: 1-5 shelf	Locking: single 01, 02, 03 (identical), 11 (individual) Interior: 1-5 shelf	Locking: single 01, 02, 03 (identical), 11 (individual) Interior: 1-5 shelf
Dimensions	H = 2090 mm	H = 2090 mm	H = 2090 mm	H = 2090 mm
Model	H54114 W/D = 1200/550 mm H44114 W/D = 1200/350 mm	H54113 W/D = 1200/550 mm H44113 W/D = 1200/350 mm	H54110 W/D = 1200/550 mm H44110 W/D = 1200/350 mm	H54115 W/D = 1200/550 mm H44115 W/D = 1200/350 mm

Folding door and sliding door cabinets

Folding door cabinets

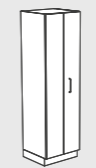
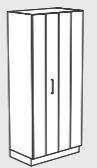
H5 (5x folder height - standard interior: 4 shelves)

			
Name	Folding door cabinet H5	Folding door cabinet H5	Folding door cabinet H5
Description	1 folding door	2 folding doors	2 folding doors
Versions	Cabinet type: assembled, front colour: white / oak Front design: left / right	Cabinet type: dismantled / assembled Front colour: white / oak	Cabinet type: dismantled / assembled Front colour: white / oak
Options	Locking: single 01, 02, 03 (identical), 11 (individual) Interior: 1-5 shelf	Locking: single 01, 02, 03 (identical), 11 (individual) Interior: 1-5 shelf	Locking: single 01, 02, 03 (identical), 11 (individual) Interior: 1-5 shelf
Dimensions	H = 2090 mm	H = 2090 mm	H = 2090 mm
Model	H55121 W/D = 600/550 mm H45121 W/D = 600/350 mm	H55122 W/D = 900/550 mm H45122 W/D = 900/350 mm	H55123 W/D = 1200/550 mm H45123 W/D = 1200/350 mm



Colour lounge

Front colours (HD01)



Sliding door cabinets

H5 (5x folder height - standard interior: 4 shelves)

			
Name	Sliding door cabinet H5	Sliding door cabinet H5	Sliding door cabinet H5
Description	2 sliding doors, with partition panel	2 partially glazed sliding doors, with partition panel	2 fully glazed sliding doors, with partition panel
Versions	Cabinet type: dismantled Front colour: white / oak	Cabinet type: dismantled Front colour: white / oak	Cabinet type: dismantled Front colour: white / oak
Options	Locking: single 01, 02, 03 (identical), 11 (individual) Interior: 1-5 shelf	Locking: single 01, 02, 03 (identical), 11 (individual) Interior: 1-5 shelf	Locking: single 01, 02, 03 (identical), 11 (individual) Interior: 1-5 shelf
Dimensions	H = 2090 mm	H = 2090 mm	H = 2090 mm
Model	H55147 W/D = 1800/550 mm H55144 W/D = 2400/550 mm	H55148 W/D = 1800/550 mm H55145 W/D = 2400/550 mm	H55149 W/D = 1800/550 mm H55146 W/D = 2400/550 mm

Wardrobe and locker cabinets

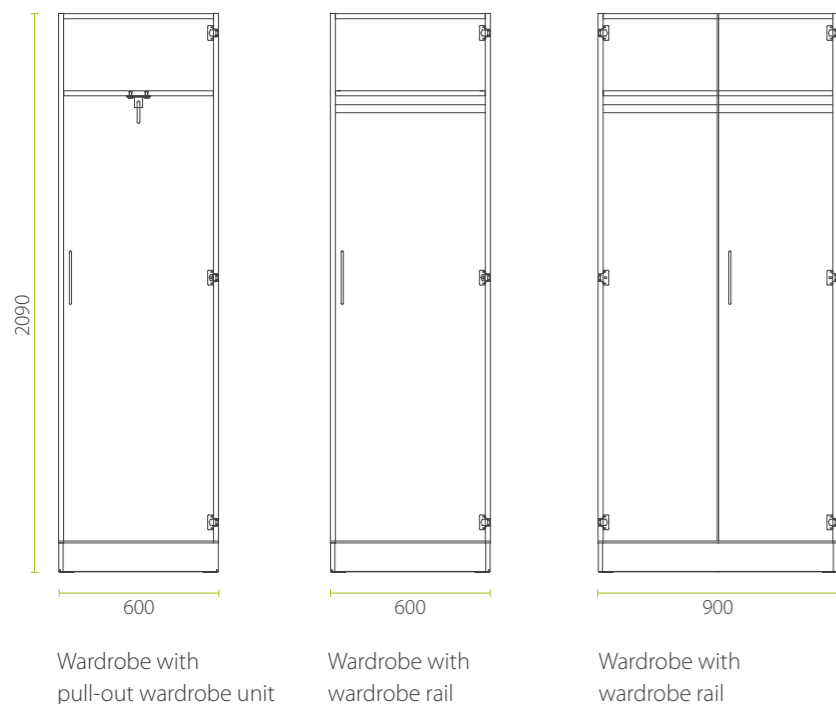

Wardrobes

H5 (standard interior: wardrobe rail)

Name	Locker cabinet H5	Wardrobe H5	Wardrobe H5	Wardrobe H5
Description	2 wing doors with partition panel, 1 shelf with wardrobe rail per side	1 wing door	2 wing doors, 1 shelf with wardrobe rail	2 wing doors, 1 shelf with wardrobe rail
Versions	Cabinet type: assembled Front colour: white / oak	Cabinet type: assembled, colour: white / oak Front design: left / right Interior: 1 shelf with wardrobe rail / 1 shelf with pull-out wardrobe unit	Cabinet type: dismantled / assembled Front colour: white / oak	Cabinet type: dismantled / assembled Front colour: white / oak
Options	Locking: single 01, 02, 03 (identical), 11 (individual)	Locking: single 01, 02, 03 (identical), 11 (individual)	Locking: single 01, 02, 03 (identical), 11 (individual)	Locking: single 01, 02, 03 (identical), 11 (individual)
Dimensions	W/H/D = 600/2090/550 mm	W/H/D = 600/2090/550 mm	W/H/D = 900/2090/550 mm	W/H/D = 1200/2090/550 mm
Model	H52111	H52110	H53109	H54116

Pigeon hole and locker cabinets

H5 (1x folder height at bottom - standard interior: 1 shelf)

Name	Pigeon hole cabinet H5	Locker cabinet H5	Locker cabinet H5
Description	6 pigeon holes at top, 1 wing door at bottom	6 lockers with individual locks at top, 1 wing door at bottom, inside locker dimensions W/H = 271/454 mm	6 lockers with individual locks, with pigeon hole at top, 1 wing door below, inside dimensions of locker W/H = 271/340 mm, inside dimensions of pigeon hole W/H = 271/50 mm
Versions	Cabinet type: assembled Front colour: white / oak Front design: left / right	Cabinet type: assembled Front colour: white / oak Front design: left / right	Cabinet type: assembled Front colour: white / oak Front design: left / right
Options	Locking: single 01, 02, 03 (identical), 11 (individual) Interior at bottom: 1 shelf	Locking: single 01, 02, 03 (identical), 11 (individual) Interior at bottom: 1 shelf	Locking: single 01, 02, 03 (identical), 11 (individual) Interior at bottom: 1 shelf
Dimensions	H = 2090 mm	H = 2090 mm	H = 2090 mm
Model	H52167 W/D = 600/550 mm H42167 W/D = 600/350 mm	H52165 W/D = 600/550 mm H42165 W/D = 600/350 mm	H52166 W/D = 600/550 mm H42166 W/D = 600/350 mm

Colour lounge

Front colours (HD01)



Garage cabinets

This makes experiments a whole lot of fun. Configure the FlexLearn cabinets with experiments, utensils or accessories and move them into the garage cabinets at floor level. The top 3 compartments are optionally available with shelves or pull-out panels and are therefore particularly variable.

- + Perfect organisation
- + Variable configuration
- + Simply practical

Tip

FlexLearn cabinet 3x1

Combine them with our matching FlexLearn cabinets 3x1 (Mod. H1431). These can easily be rolled in and locked up securely. The side panels are available in 11 different colours - consequently you can organise a separate caddy for each topic or subject.

FlexLearn boxes

Fill the garage cabinet and the FlexLearn cabinets with our FlexLearn boxes. These are available in 4 different heights and 7 fresh colours.

Garage cabinets for FlexLearn box & FlexLearn cabinet 3x1

H5 (standard interior: 3x 2 shelves)

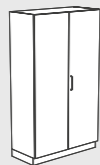
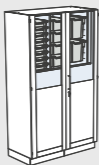
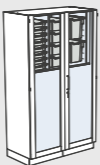
			
Name	Garage cabinet H5	Garage cabinet H5	Garage cabinet H5
Description	2 wing doors with mobile plinth, upper compartment with 2 partition panels, suitable for up to 27 FlexLearn boxes 75, lower compartment open, suitable for 3 FlexLearn cabinets 3x1	2 partially glazed wing doors with mobile plinth, upper compartment with 2 partition panels, suitable for up to 27 FlexLearn boxes 75, lower compartment open, suitable for 3 FlexLearn cabinets 3x1	2 fully glazed wing doors with mobile plinth, upper compartment with 2 partition panels, suitable for up to 27 FlexLearn boxes 75, lower compartment open, suitable for 3 FlexLearn cabinets 3x1
Versions	Cabinet type: dismantled Front colour: white / oak	Cabinet type: dismantled Front colour: white / oak	Cabinet type: dismantled Front colour: white / oak
Options	Locking: single 01, 02, 03 (identical), 11 (individual) Interior (column 1-3): 3x 2 shelves / 3 pairs of pull-out panels (panel colour: ME01)	Locking: single 01, 02, 03 (identical), 11 (individual) Interior (column 1-3): 3x 2 shelves / 3 pairs of pull-out panels (panel colour: ME01)	Locking: single 01, 02, 03 (identical), 11 (individual) Interior (column 1-3): 3x 2 shelves / 3 pairs of pull-out panels (panel colour: ME01)
Dimensions	W/H/D = 1200/2090/600 mm	W/H/D = 1200/2090/600 mm	W/H/D = 1200/2090/600 mm
Model	H54126	H54128	H54129

Colour lounge

Front colours (HD01)





Panel colours (ME01)





Garage cabinets

Garage Cabinets for Tableaux & Multi-Mobile

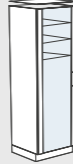
H5 (standard interior: 2 shelves)

			
Name	Garage cabinet H5	Garage cabinet H5	Garage cabinet H5
Description	1 wing door with mobile plinth, suitable for experiment tableaux at the top and 1 Multi-Mobile at the bottom	1 partially glazed wing door with mobile plinth, suitable for experiment tableaux at the top and 1 Multi-Mobile at the bottom	1 fully glazed wing door with mobile plinth, suitable for experiment tableaux at the top and 1 Multi-Mobile at the bottom
Versions	Cabinet type: assembled Front colour: white / oak Front design: left / right	Cabinet type: assembled Front colour: white / oak Front design: left / right	Cabinet type: assembled Front colour: white / oak Front design: left / right
Options	Locking: single 01, 02, 03 (identical), 11 (individual) Interior: 2 shelves / 1 pair of pull-out panels (panel colour: ME01)	Locking: single 01, 02, 03 (identical), 11 (individual) Interior: 2 shelves / 1 pair of pull-out panels (panel colour: ME01)	Locking: single 01, 02, 03 (identical), 11 (individual) Interior: 2 shelves / 1 pair of pull-out panels (panel colour: ME01)
Dimensions	W/H/D = 600/2090/600 mm	W/H/D = 600/2090/600 mm	W/H/D = 600/2090/600 mm
Model	H52123	H52124	H52125

H5 (standard interior: 2x 2 shelves)

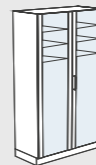
			
Name	Garage cabinet H5	Garage cabinet H5	Garage cabinet H5
Description	2 wing doors with mobile plinth, top compartment with partition panel, suitable for experiment tableaux, bottom compartment open, suitable for 2 Multi-Mobiles	2 partially glazed wing doors with mobile plinth, top compartment with partition panel, suitable for experiment tableaux, bottom compartment open, suitable for 2 Multi-Mobiles	2 fully glazed wing doors with mobile plinth, top compartment with partition panel, suitable for experiment tableaux, bottom compartment open, suitable for 2 Multi-Mobiles
Versions	Cabinet type: dismantled Front colour: white / oak	Cabinet type: dismantled Front colour: white / oak	Cabinet type: dismantled Front colour: white / oak
Options	Locking: single 01, 02, 03 (identical), 11 (individual) Interior (column 1-2): 2x 2 shelves / 2 pairs of pull-out panels (panel colour: ME01)	Locking: single 01, 02, 03 (identical), 11 (individual) Interior (column 1-2): 2x 2 shelves / 2 pairs of pull-out panels (panel colour: ME01)	Locking: single 01, 02, 03 (identical), 11 (individual) Interior (column 1-2): 2x 2 shelves / 2 pairs of pull-out panels (panel colour: ME01)
Dimensions	W/H/D = 1200/2090/600 mm	W/H/D = 1200/2090/600 mm	W/H/D = 1200/2090/600 mm
Model	H54123	H54124	H54125

Colour lounge

Front colours (HD01)



Panel colours (ME01)



Collection cabinets

Everything fits in here. Our collection cabinets can be infinitely stringed together and ensure for a lot of transparency, thanks to the use of large format safety glass.

The open partition walls provide the possibility of cabinet overlapping use, the open rear wall on the free-standing cabinets enables the storage of particularly large exhibits.

-  Perfect organisation
-  High transparency
-  Lots of storage space

Wall-standing collection cabinets

H5 (5x folder height - standard interior: 4 shelves)

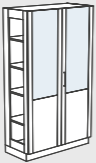
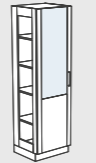
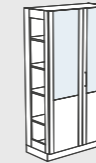
				
Name	Base unit, 1-sided	Add-on unit, 1-sided	End unit, 1-sided	End unit, 1-sided
Description	2 partially glazed wing doors, side panel closed on left, open on right	2 partially glazed wing doors, side panel open left + right	1 partially glazed wing door, side panel open on left, closed on right	2 partially glazed wing doors, side panel open on left, closed on right
Versions	Cabinet type: dismantled / assembled Front colour: white / oak	Cabinet type: dismantled / assembled Front colour: white / oak	Cabinet type: assembled Front colour: white / oak Front design: left / right	Cabinet type: dismantled / assembled Front colour: white / oak
Options	Locking: single 01, 02, 03 (identical), 11 (individual) Interior: 1-5 shelf	Locking: single 01, 02, 03 (identical), 11 (individual) Interior: 1-5 shelf	Locking: single 01, 02, 03 (identical), 11 (individual) Interior: 1-5 shelf	Locking: single 01, 02, 03 (identical), 11 (individual) Interior: 1-5 shelf
Dimensions	W/H/D = 1200/2090/550 mm	W/H/D = 1200/2090/550 mm	W/H/D = 600/2090/550 mm	W/H/D = 1200/2090/550 mm
Model	H56121	H56122	H56123	H56124

				
Name	Base unit, 1-sided	Add-on unit, 1-sided	End unit, 1-sided	End unit, 1-sided
Description	2 fully glazed wing doors, side panel closed on left, open on right	2 fully glazed wing doors, side panel open left + right	1 fully glazed wing door, side panel open on left, closed on right	2 fully glazed wing doors, side panel open on left, closed on right
Versions	Cabinet type: dismantled / assembled Front colour: white / oak	Cabinet type: dismantled / assembled Front colour: white / oak	Cabinet type: assembled Front colour: white / oak Front design: left / right	Cabinet type: dismantled / assembled Front colour: white / oak
Options	Locking: single 01, 02, 03 (identical), 11 (individual) Interior: 1-5 shelf	Locking: single 01, 02, 03 (identical), 11 (individual) Interior: 1-5 shelf	Locking: single 01, 02, 03 (identical), 11 (individual) Interior: 1-5 shelf	Locking: single 01, 02, 03 (identical), 11 (individual) Interior: 1-5 shelf
Dimensions	W/H/D = 1200/2090/550 mm	W/H/D = 1200/2090/550 mm	W/H/D = 600/2090/550 mm	W/H/D = 1200/2090/550 mm
Model	H56111	H56112	H56113	H56114

Free-standing collection cabinets

H5 (5x folder height - standard interior: 4 shelves per side)

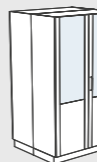
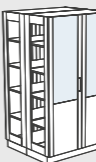
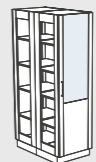
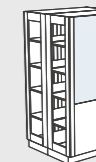
				
Name	Base unit, 2-sided	Add-on unit, 2-sided	End unit, 2-sided	End unit, 2-sided
Description	4 partially glazed wing doors, side panel closed on left, open on right	4 partially glazed wing doors, side panel open on left + right	2 partially glazed wing doors, side panel open on left, closed on right	4 partially glazed wing doors, side panel open on left, closed on right
Versions	Cabinet type: dismantled Front colour: white / oak	Cabinet type: dismantled Front colour: white / oak	Cabinet type: dismantled Front colour: white / oak Front design: left / right	Cabinet type: dismantled Front colour: white / oak
Options	Locking: single 01, 02, 03 (identical), 11 (individual) Interior: 1-5 shelf	Locking: single 01, 02, 03 (identical), 11 (individual) Interior: 1-5 shelf	Locking: single 01, 02, 03 (identical), 11 (individual) Interior: 1-5 shelf	Locking: single 01, 02, 03 (identical), 11 (individual) Interior: 1-5 shelf
Dimensions	W/H/D = 1200/2090/1100 mm	W/H/D = 1200/2090/1100 mm	W/H/D = 600/2090/1100 mm	W/H/D = 1200/2090/1100 mm
Model	H57121	H57122	H57123	H57124

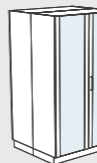
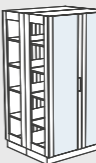
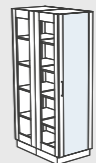
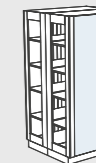
				
Name	Base unit, 2-sided	Add-on unit, 2-sided	End unit, 2-sided	End unit, 2-sided
Description	4 fully glazed wing doors, side panel open on right	4 fully glazed wing doors, side panel open on left + right	2 fully glazed wing doors, side panel open on left	4 fully glazed wing doors, side panel open on left
Versions	Cabinet type: dismantled Front colour: white / oak	Cabinet type: dismantled Front colour: white / oak	Cabinet type: dismantled Front colour: white / oak Front design: left / right	Cabinet type: dismantled Front colour: white / oak
Options	Locking: single 01, 02, 03 (identical), 11 (individual) Interior: 1-5 shelf	Locking: single 01, 02, 03 (identical), 11 (individual) Interior: 1-5 shelf	Locking: single 01, 02, 03 (identical), 11 (individual) Interior: 1-5 shelf	Locking: single 01, 02, 03 (identical), 11 (individual) Interior: 1-5 shelf
Dimensions	W/H/D = 1200/2090/1100 mm	W/H/D = 1200/2090/1100 mm	W/H/D = 600/2090/1100 mm	W/H/D = 1200/2090/1100 mm
Model	H57111 SP on left closed H57131 SP on left fully glazed	H57112	H57113 SP on right closed H57133 SP on right fully glazed	H57114 SP on right closed H57134 SP on right fully glazed

		
Name	Individual unit, 2-sided	Individual unit, 2-sided
Description	4 partially glazed wing doors, side panel closed on left + right	4 fully glazed wing doors
Versions	Cabinet type: dismantled Front colour: white / oak	Cabinet type: dismantled Front colour: white / oak
Options	Locking: single 01, 02, 03 (identical), 11 (individual) Interior: 1-5 shelf	Locking: single 01, 02, 03 (identical), 11 (individual) Interior: 1-5 shelf
Dimensions	W/H/D = 1200/2090/1100 mm	W/H/D = 1200/2090/1100 mm
Model	H57109	H57110 SP closed l + r H57130 SP fully glazed l + r

Colour lounge

Front colours (HD01)



Special cabinets

Kitchenette cabinet

H5



Kitchenette cabinet H5

Description	2 wing doors, work surface with basin/siphon
Versions	Front colour: white / oak
Options	Hotplate, base cabinet with refrigerator
Dimensions	W/H/D = 1200/2090/600 mm

Info

On request we are pleased to offer you various types of kitchenette cabinets.

First aid cabinet

H5 (5x folder height - standard interior: 2 shelves)



First aid cabinet H5

Description	1 wing door, incl. first aid case, 1 fire extinguisher 5 kg, 2 sandboxes, 1 sand shovel, 2 fire blankets
Versions	Cabinet type: assembled Front colour: white / oak Front design: left / right
Options	Interior: 1-5 shelf / 1-5 pull-out shelf
Dimensions	H = 2090 mm

Model	H52113 W/D = 600/550 mm
	H42113 W/D = 600/350 mm

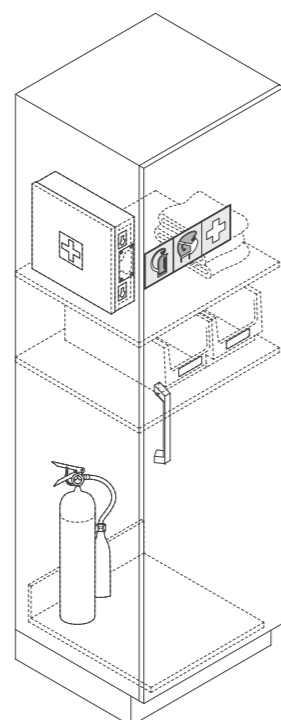

Colour lounge

Front colours (HD01)







Small parts

Accessories

			
Name	Bucket	Extinguishing sand	Shovel
Description	Bucket 10 litres made from galvanised steel plate, powder-coated red RAL 3000	Extinguishing sand 10 kg, grain size 0-2 mm	Shovel made from steel plate, painted black, with wooden handle and hanger ring
Dimensions			W/H = 110/400 mm
Model	163044	704639	163046

First Aid

				
Name	First aid cabinet	First aid case	Fire blanket container	Powder extinguisher
Description	First aid cabinet made from plastic, white, 1 lockable door, 2 adjustable shelves, spacious door compartments, with filling, contents acc. DIN 13157	First aid case, contents acc. DIN 13157, durability 20 years, incl. wall mount	Fire blanket container made from steel plate plastic-coated red, turn lock, with filling (1 fire blanket acc. DIN 1869, 1 pair of heat-protection gloves KSA)	Powder extinguisher, 6 kg, for fire classes ABC acc. DIN EN3, CE
Dimensions	W/H/D = 315/430/150 mm	W/H/D = 310/210/130 mm		
Model	9056	9055	9749	9750

Cabinets for refrigeration and heating technology

Cabinet for heating technology

H5 (standard interior: 2 shelves)

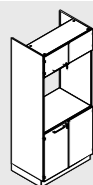

Cabinet for heating technology H5	
Description	2 wing doors above + below, middle compartment without rear wall, inside dimensions W/H/D = 862/880/563 mm, suitable for incubators / stand-alone units
Versions	Cabinet type: dismantled Front colour: white / oak
Options	Locking: single 01, 02, 03 (identical), 11 (individual) Interior at bottom: 1-2 shelf / 1-2 pull-out shelf
Dimensions	W/H/D = 900/2090/600 mm
Model	H52105



Incubator and heating cabinet	
Description	Incubator and heating cabinet, brand Memmert UN30, stainless steel door, temperature range at least 5 °C above room temperature to +300 °C, capacity 32 litres, inside dimensions W/H/D = 400/320/250 mm, Connected load: 230 V, approx. 1600 W
Dimensions	W/H/D = 585/704/434 mm
Model	H9755
	168907 Wall bracket

Special features

- › Precise drying, heating, tempering, ageing, stove enamelling, testing and curing with sophisticated technical equipment
- › Comfortable operation with digital PID-microprocessor controller with high resolution TFT colour graphic display
- › Easy to clean due to high quality and hygienic stainless steel
- › Versatile use due to flexible ventilation technology, control technology, overtemperature protection and precisely coordinated heating technology

Cabinets for refrigeration technology

H5



	Cabinet for refrigeration technology H5	Cabinet for refrigeration technology H5
Name	Cabinet for refrigeration technology H5	Cabinet for refrigeration technology H5
Description	1 wing door above + below, 1 free compartment in the middle for the installation of a standard refrigerator or freezer	2 free compartments for the installation of refrigerators and/or freezer cabinets
Versions	Cabinet type: assembled Front colour: white / oak Front design: left / right	Cabinet type: assembled Front colour: white / oak Front design: left / right
Options	Locking: single 01, 02, 03 (identical), 11 (individual) Interior at bottom: 1-2 shelf / 1-2 pull-out shelf	
Dimensions	W/H/D = 600/2090/600 mm	W/H/D = 600/2090/600 mm
Model	H52104	H52115 

Info

When using top-mounted cabinets, use only 550 mm deep models with exhaust air duct. This ensures sufficient rear ventilation.

Colour lounge

Front colours (HD01)



Refrigerators

	Refrigerator	Refrigerator with freezer compartment	Freezer cabinet
Description	Refrigerator, brand Liebherr, can be integrated in the cabinet models H52104 and H52115 CFC-free; usable volume 151 litres; annual energy consumption 98 kWh; Energy Efficiency Class A++, Connected load: 220/230 V, 110 W	Refrigerator with freezer compartment, brand Liebherr, can be integrated in the cabinet models H52104 and H52115 CFC-free; usable volume refrigeration compartment 118 litres; usable volume 4-star freezer compartment (-18 degrees C) 16 litres; annual energy consumption 151 kWh; energy efficiency class A++, Connected load: 220/230 V, 110 W	Freezer cabinet, brand Liebherr, can be integrated in the cabinet models H52104 and H52115 CFC-free; 4 drawers; usable volume 100 litres; annual energy consumption 159 kWh; energy efficiency class A++, Connected load: 220/230 V, 110 W
Dimensions	W/H/D = 560/880/550 mm	W/H/D = 560/880/550 mm	W/H/D = 560/880/550 mm
Model	909765	909763	909767
	909766 Explosion-protected	909764 Explosion-protected	909768 Explosion-protected

 Available to order soon

Cabinets for chemicals

Cabinets for chemicals

H5

Name	Cabinet for chemicals H5	Cabinet for chemicals H5	Cabinet for chemicals H5
Description	1 wing door, incl. air vents for extraction, without interior fittings	2 wing doors, incl. air vents for extraction, without interior fittings	1 wing door, with integrated lockable compartment for toxic substances (incl. 1 shelf), inside dimensions of toxic substances compartment W/H/D = 561/564/331 mm, incl. air vents for extraction
Exhaust air	Air vent: Ø 90 mm Planning recommendation: 30 m³/h	Air vent: Ø 90 mm Planning recommendation: 30 m³/h	Air vent: Ø 90 mm Planning recommendation: 50 m³/h
Versions	Cabinet type: assembled Front colour: white / oak Front design: left / right	Cabinet type: assembled Front colour: white / oak	Cabinet type: assembled Front colour: white / oak Front design: left / right
Options	Locking: single 01, 02, 03 (identical), 11 (individual)	Locking: single 01, 02, 03 (identical), 11 (individual)	Locking: single 01, 02, 03 (identical), 11 (individual) Interior: 1-3 shelf
Dimensions	H = 2090 mm	H = 2090 mm	H = 2090 mm
Model	H52177 W/D = 600/550 mm	H53177 W/D = 900/550 mm H54177 W/D = 1200/550 mm	H52176 W/D = 600/550 mm

Colour lounge

Front colours (HD01)



Pull-out cabinets

H5

Name	Pull-out cabinet H5	Pull-out cabinet H5
Description	2 pull-out units, 5 height-adjustable hanging baskets with polyethylene catch tray per pull-out unit, hanging basket made from coated steel wire, loadbearing capacity per pull-out unit 120 kg, loadbearing capacity per hanging basket 10 kg	3 pull-out units, 5 height-adjustable hanging baskets with polyethylene catch tray per pull-out unit, hanging basket made from coated steel wire, loadbearing capacity per pull-out unit 120 kg, loadbearing capacity per hanging basket 10 kg
Exhaust air	Air vent: Ø 90 mm Planning recommendation: 30 m³/h	Air vent: Ø 90 mm Planning recommendation: 30 m³/h
Versions	Cabinet type: assembled Front colour: white / oak	Cabinet type: assembled Front colour: white / oak
Options	Locking: single 01, 02, 03 (identical), 11 (individual) Air vents for extraction	Locking: single 01, 02, 03 (identical), 11 (individual) Air vents for extraction
Dimensions	W/H/D = 600/2090/550 mm	W/H/D = 900/2090/550 mm
Model	H52226	H53226

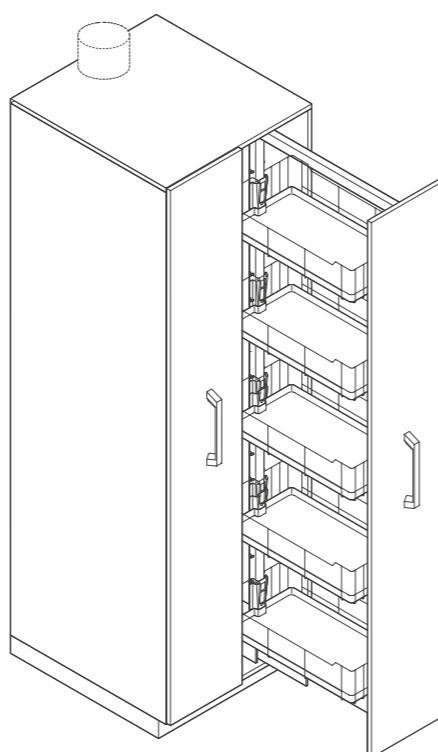

Acid and alkali cabinet

H5 (standard interior: 4 pull-out shelves incl. PP tray)

Acid and alkali cabinet H5	
Description	2 wing doors, separate compartments for acids and alkalis, catch trays made from polypropylene, coated fittings, incl. air vents for extraction
Exhaust air	Air vent: Ø 90 mm Planning recommendation: 100 m³/h
Versions	Cabinet type: assembled Front colour: white / oak Front design: left / right
Options	Locking: single 01, 02, 03 (identical), 11 (individual) Interior incl. PP trays: 2 / 4 shelves / 2 / 4 pull-out shelves
Dimensions	W/H/D = 600/2090/550 mm
Model	H5509

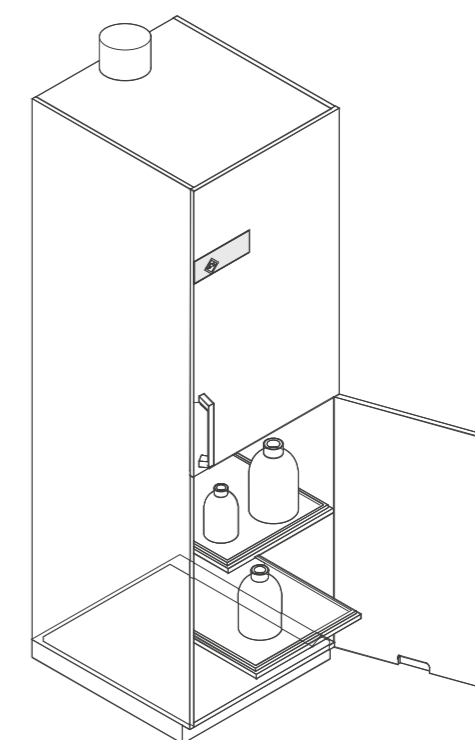

All-in-one cabinet for hazardous substances

H5 (standard interior: 4 pull-out shelves incl. PP tray)

Name	All-in-one cabinet for hazardous substances H5	Hazardous materials base cabinet
Description	2 wing doors, separate compartments for acids and alkalis, middle compartment with 2 pull-out shelves incl. PP tray, coated fittings, integrated hazardous materials cabinet at bottom, incl. air vents for extraction	Fire-resistant hazardous materials base cabinet (G 90) made from steel plate, white, for the safe and proper storage of combustible liquids, 1 drawer with locking cylinder, inside dimensions W/H/D = 461/480/363 mm
Exhaust air	Air vent: Ø 90 mm Planning recommendation: 80 m³/h (incl. hazardous materials base cabinet)	
Versions	Cabinet type: assembled Front colour: white / oak Front design: left / right, interior top compartment: 1 shelf (without PP tray) / 2 pull-out shelves with PP tray	
Options	Locking: single 01, 02, 03 (identical), 11 (individual)	
Dimensions	W/H/D = 600/2090/650 mm	W/H/D = 558/643/495 mm
Model	H5507	143835



All-in-one cabinets for hazardous materials



Info

Top-mounted cabinets

Due to the product safety, top-mounted cabinets are only possible with hazardous materials cabinets from the company Asecos.

Name	All-in-one cabinet for hazardous substances 600	All-in-one cabinet for hazardous substances 900	All-in-one cabinet for hazardous substances 1200
Description	1 wing door with lock, incl. 3 tray shelves and 1 bottom tray with perforated sheet insert, incl. connection branches for supply and exhaust air, weight: 286 kg (Düperthal) / 260 kg (Asecos)	2 wing doors with lock, incl. 3 tray shelves and 1 bottom tray with perforated sheet insert, incl. connection branches for supply and exhaust air, weight: 358 kg (Düperthal) / 310 kg (Asecos)	2 wing doors with lock, incl. 3 tray shelves and 1 bottom tray with perforated sheet insert, incl. connection branches for supply and exhaust air, weight: 469 kg (Düperthal) / 420 kg (Asecos)
Exhaust air	Air vent: Ø 75 mm Planning recommendation: 30 m ³ /h	Air vent: Ø 75 mm Planning recommendation: 30 m ³ /h	Air vent: Ø 75 mm Planning recommendation: 30 m ³ /h
Versions	Manufacturer: Düperthal / Asecos Colour: white (RAL 9010) Front design: left / right	Manufacturer: Düperthal / Asecos Colour: white (RAL 9010)	Manufacturer: Düperthal / Asecos Colour: white (RAL 9010)
Options	Height compensation panel, interior also includes: 1 tray shelf (only Asecos)	Height compensation panel, interior also includes: 1 tray shelf (only Asecos)	Height compensation panel, interior also includes: 1 tray shelf (only Asecos)
Dimensions	W/H/D = approx. 600/2000/600 mm	W/H/D = approx. 900/2000/600 mm	W/H/D = approx. 1200/2000/600 mm
Model	9151	9155	9150



Tray shelf (Asecos)



Cabinets for pressurised gas cylinders





Info

Top-mounted cabinets

Due to the product safety, top-mounted cabinets are only possible with pressurised gas cylinder cabinets from the company Asecos.



			
Name	DGF cabinet 600	DGF cabinet 900	DGF cabinet 1200
Description	1 wing door with lock, for 2 pressurised gas cylinders (max. 10 litres), incl. connection branches for air supply and exhaust air Weight: 283 kg (Düperthal) / 290 kg (Asecos)	2 wing doors with lock, for 3 pressurised gas cylinders (max. 10 litres), incl. connection branches for air supply and exhaust air Weight: 420 kg (Düperthal) / 340 kg (Asecos)	2 wing doors with lock, for 4 pressurised gas cylinders (max. 10 litres), incl. connection branches for air supply and exhaust air Weight: 523 kg (Düperthal) / 470 kg (Asecos)
Exhaust air	Air vent: Ø 75 mm Planning recommendation: 60 m³/h	Air vent: Ø 75 mm Planning recommendation: 90 m³/h	Air vent: Ø 75 mm Planning recommendation: 120 m³/h
Versions	Manufacturer/model: Düperthal G30 / Düperthal G90 / Asecos G30 / Asecos G90 Colour: white (RAL 9010) Front design: left / right	Manufacturer/model: Düperthal G30 / Düperthal G90 / Asecos G30 / Asecos G90 Colour: white (RAL 9010)	Manufacturer/model: Düperthal G30 / Düperthal G90 / Asecos G30 / Asecos G90 Colour: white (RAL 9010)
Options	Height compensation panel Interior: 1 intermediate shelf (only Düperthal) Add-on: cylinder rack and clamping fixture	Height compensation panel Interior: 1 intermediate shelf (only Düperthal) Add-on: cylinder rack and clamping fixture	Height compensation panel Interior: 1 intermediate shelf (only Düperthal) Add-on: cylinder rack and clamping fixture
Dimensions	W/H/D = approx. 600/2000/600 mm	W/H/D = approx. 900/2000/600 mm	W/H/D = approx. 1200/2000/600 mm
Model	9152	9154	9153





Intermediate shelf



Cylinder rack and clamping fixture

Gas cylinder trolley

		
Name	Gas cylinder trolley	Gas cylinder trolley
Description	For 1x10 Litre cylinder, loadbearing capacity 100 kg	For 2x10 Litre cylinders, loadbearing capacity 50 kg
Dimensions	W/H/D = 280/1000/320 mm	W/H/D = 360/1000/320 mm
Model	H9023	H9024

Info

Our gas cylinder trolleys can be pushed directly into the cabinet and stored there fitting perfectly.

Top-mounted cabinets

Top-mounted cabinets for tall cabinets

H1 (1x folder height - standard interior: 1 shelf)

		
Name	Top-mounted cabinet H1	Top-mounted cabinet H1
Description	1 wing door	2 wing doors
Versions	Type: with / without ladder rail, with / without waste air leadthrough (only with D = 550 mm) Front colour: white / oak Front design: left / right	Type: with / without ladder rail, with / without waste air leadthrough (only with D = 550 mm) Front colour: white / oak
Options	Locking: single 01, 02, 03 (identical), 11 (individual) Interior: 1 shelf	Locking: single 01, 02, 03 (identical), 11 (individual) Interior: 1 shelf
Dimensions	H = 610 mm	H = 610 mm
Model	H51712 W/D = 450/550 mm H41712 W/D = 450/350 mm H52712 W/D = 600/550 mm H42712 W/D = 600/350 mm	H53712 W/D = 900/550 mm H43712 W/D = 900/350 mm H54712 W/D = 1200/550 mm H44712 W/D = 1200/350 mm

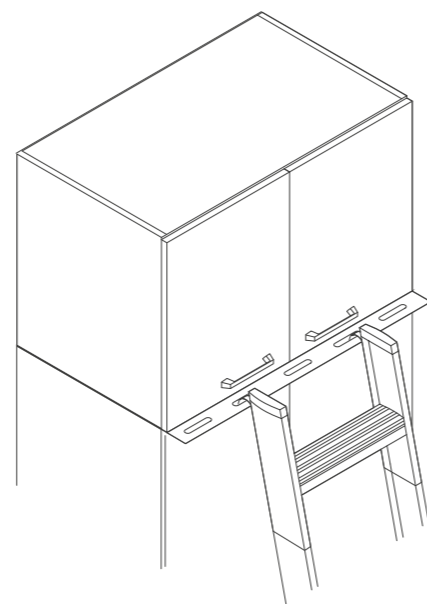

Optional ladder rail

H2 (2x folder height - standard interior: 1 shelf)

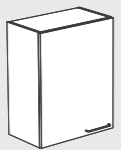
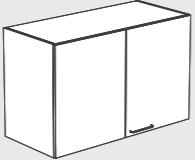
		
Name	Top-mounted cabinet H2	Top-mounted cabinet H2
Description	1 wing door	2 wing doors
Versions	Type: with / without ladder rail, with / without waste air leadthrough (only with D = 550 mm) Front colour: white / oak Front design: left / right	Type: with / without ladder rail, with / without waste air leadthrough (only with D = 550 mm) Front colour: white / oak
Options	Locking: single 01, 02, 03 (identical), 11 (individual) Interior: 1 shelf	Locking: single 01, 02, 03 (identical), 11 (individual) Interior: 1 shelf
Dimensions	H = 760 mm	H = 760 mm
Model	H51722 W/D = 450/550 mm H41722 W/D = 450/350 mm H52722 W/D = 600/550 mm H42722 W/D = 600/350 mm	H53722 W/D = 900/550 mm H43722 W/D = 900/350 mm H54722 W/D = 1200/550 mm H44722 W/D = 1200/350 mm

Colour lounge

Front colours (HD01)



Info

Because of the design principle, the top-mounted cabinets cannot be used as wall-mounted cabinets.

Top-mounted cabinets for corner cabinets

H1 (1x folder height - standard interior: 1 shelf)

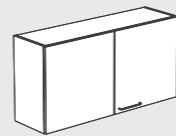
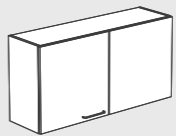
		
Name	Top-mounted cabinet H1	Top-mounted cabinet H1
Description	1 fixed panel on left, 1 wing door on right	1 fixed panel on right, 1 wing door on left
Versions	Type: with / without ladder rail, with / without waste air leadthrough (only with D = 550 mm) Front colour: white / oak	Type: with / without ladder rail, with / without waste air leadthrough (only with D = 550 mm) Front colour: white / oak
Options	Locking: single 01, 02, 03 (identical), 11 (individual) Interior: 1 shelf	Locking: single 01, 02, 03 (identical), 11 (individual) Interior: 1 shelf
Dimensions	H = 610 mm	H = 610 mm
Model	H44714 W/D = 1200/550 mm H54714 W/D = 1200/350 mm	H44715 W/D = 1200/550 mm H54715 W/D = 1200/350 mm

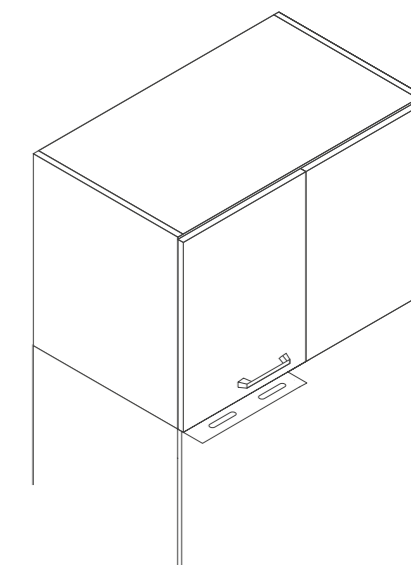

H2 (2x folder height - standard interior: 1 shelf)

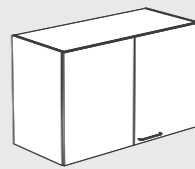
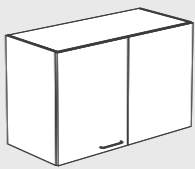
		
Name	Top-mounted cabinet H2	Top-mounted cabinet H2
Description	1 fixed panel on left, 1 wing door on right	1 fixed panel on right, 1 wing door on left
Versions	Type: with / without ladder rail, with / without waste air leadthrough (only with D = 550 mm) Front colour: white / oak	Type: with / without ladder rail, with / without waste air leadthrough (only with D = 550 mm) Front colour: white / oak
Options	Locking: single 01, 02, 03 (identical), 11 (individual) Interior: 1 shelf	Locking: single 01, 02, 03 (identical), 11 (individual) Interior: 1 shelf
Dimensions	H = 760 mm	H = 760 mm
Model	H44716 W/D = 1200/550 mm H54716 W/D = 1200/350 mm	H44717 W/D = 1200/550 mm H54717 W/D = 1200/350 mm

 Available to order soon

Wall-mounted cabinets

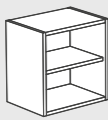
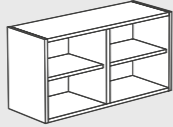
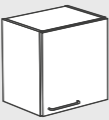
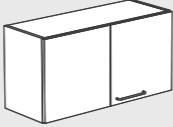

H1 (1x folder height - standard interior: 1 shelf)

				
Name	Wall-mounted cabinet H1	Wall-mounted cabinet H1	Wall-mounted cabinet H1	Wall-mounted cabinet H1
Description	Open cupboard shelves	Open cupboard shelves, with partition panel	1 wing door	2 wing doors, with partition panel
Versions	Type: wall mounting / cell mounting	Type: wall mounting / cell mounting	Type: wall mounting / cell mounting Front colour: white / oak Front design: left / right	Type: wall mounting / cell mounting Front colour: white / oak
Options	Interior: 1 shelf	Interior per side: 1 shelf	Locking: single 01, 02, 03 (identical), 11 (individual) Interior: 1 shelf	Locking: single 01, 02, 03 (identical), 11 (individual) Interior per side: 1 shelf
Dimensions	H = 460 mm	H = 460 mm	H = 460 mm	H = 460 mm
Model	H41673 W/D = 450/330 mm H42673 W/D = 600/330 mm	H43673 W/D = 900/330 mm H44673 W/D = 1200/330 mm	H41672 W/D = 450/350 mm H42672 W/D = 600/350 mm	H43672 W/D = 900/350 mm H44672 W/D = 1200/350 mm

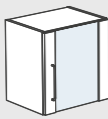
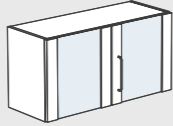
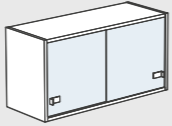
			
Name	Wall-mounted cabinet H1	Wall-mounted cabinet H1	Wall-mounted cabinet H1
Description	1 fully glazed wing door	2 fully glazed wing doors, with partition panel	2 fully glazed sliding doors, with partition panel
Versions	Type: wall mounting / cell mounting Front colour: white / oak Front design: left / right	Type: wall mounting / cell mounting Front colour: white / oak	Type: wall mounting / cell mounting Front colour: white / oak
Options	Locking: single 01, 02, 03 (identical), 11 (individual) Interior: 1 shelf	Locking: single 01, 02, 03 (identical), 11 (individual) Interior per side: 1 shelf	Locking: single 01, 02, 03 (identical), 11 (individual) Interior per side: 1 shelf
Dimensions	H = 460 mm	H = 460 mm	H = 460 mm
Model	H41670 W/D = 450/350 mm H42670 W/D = 600/350 mm	H43670 W/D = 900/350 mm H44670 W/D = 1200/350 mm	H43675 W/D = 900/350 mm H44675 W/D = 1200/350 mm

Colour lounge

Front colours (HD01)

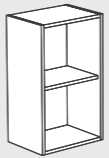
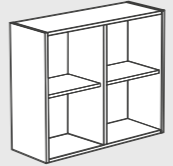
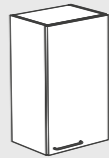
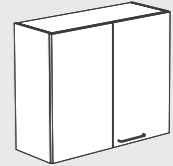

H2 (2x folder height - standard interior: 1 shelf)

				
Name	Wall-mounted cabinet H2	Wall-mounted cabinet H2	Wall-mounted cabinet H2	Wall-mounted cabinet H2
Description	Open cupboard shelves	Open cupboard shelves, with partition panel	1 wing door	2 wing doors, with partition panel
Versions	Type: wall mounting / cell mounting	Type: wall mounting / cell mounting	Type: wall mounting / cell mounting Front colour: white / oak Front design: left / right	Type: wall mounting / cell mounting Front colour: white / oak
Options	Interior: 1 shelf	Interior per side: 1 shelf	Locking: single 01, 02, 03 (identical), 11 (individual) Interior: 1 shelf	Locking: single 01, 02, 03 (identical), 11 (individual) Interior per side: 1 shelf
Dimensions	H = 760 mm	H = 760 mm	H = 760 mm	H = 760 mm
Model	H41473 W/D = 450/350 mm H42473 W/D = 600/350 mm	H43473 W/D = 900/350 mm H44473 W/D = 1200/350 mm	H41472 W/D = 450/350 mm H42472 W/D = 600/350 mm	H43472 W/D = 900/350 mm H44472 W/D = 1200/350 mm

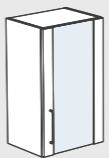
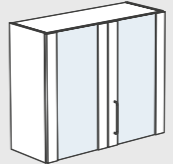
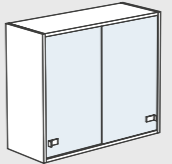
			
Name	Wall-mounted cabinet H2	Wall-mounted cabinet H2	Wall-mounted cabinet H2
Description	1 fully glazed wing door	2 fully glazed wing doors, with partition panel	2 fully glazed sliding doors, with partition panel
Versions	Type: wall mounting / cell mounting Front colour: white / oak Front design: left / right	Type: wall mounting / cell mounting Front colour: white / oak	Type: wall mounting / cell mounting Front colour: white / oak
Options	Locking: single 01, 02, 03 (identical), 11 (individual) Interior: 1 shelf	Locking: single 01, 02, 03 (identical), 11 (individual) Interior per side: 1 shelf	Locking: single 01, 02, 03 (identical), 11 (individual) Interior per side: 1 shelf
Dimensions	H = 760 mm	H = 760 mm	H = 760 mm
Model	H41470 W/D = 450/350 mm H42470 W/D = 600/350 mm	H43470 W/D = 900/350 mm H44470 W/D = 1200/350 mm	H43475 W/D = 900/350 mm H44475 W/D = 1200/350 mm

Range of panels

Front panels

			
Name	Front panel L/R	Front panel inside corner	Front panel at top
Description	Front panel for wall connection left/right, incl. plinth anthracite, panelling flush with carcass, incl. assembly material	Front panel for inside corner angle, incl. plinth anthracite, panelling flush with carcass, incl. assembly material	Front panel for ceiling connection above, panelling flush with carcass, incl. assembly material
Versions	Colour: white / oak Width: 160 / 300 / 600 mm	Colour: white / oak Width: 300 x 300 / 500 x 500 mm	Colour: white / oak Height: 150 / 300 / 610 / 760 / 1200 mm
Model	H60010 H1 = 720 mm H60011 H2 = 870 mm H60012 H3 = 1220 mm H60013 H5 = 2090 mm H60014 H6 = 2700 mm H60015 H7 = 2850 mm	H60020 H1 = 720 mm H60021 H2 = 870 mm H60022 H3 = 1220 mm H60023 H5 = 2090 mm	H60030 W = 450 mm H60031 W = 600 mm H60032 W = 900 mm H60033 W = 1200 mm H60034 W = 1500 mm H60035 W = 1800 mm H60036 W = 2100 mm H60037 W = 2400 mm

Colour lounge

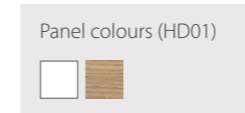

Splash protection panels

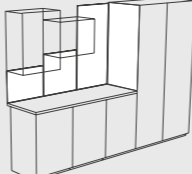
	
Splash protection panel	
Description	Panel made from 5 mm solid core material
Versions	Colour: white Width: Flex (100 - 2600 mm)
Model	82003213 H = 422 mm 82003214 H = 572 mm 82003215 H = 1182 mm

Side panels

			
Name	Side panel rear	Side panel rear	Side panel above
Description	Side panel for rear wall connection, incl. plinth anthracite, panelling flush with carcass, incl. assembly material	Side panel for rear wall connection, incl. plinth anthracite, panelling flush with carcass, incl. assembly material	Side panel for ceiling connection above, panelling flush with carcass, incl. assembly material
Versions	Colour: white Width: 85 / 160 / 285 / 360 mm	Colour: white Width: 160 / 360 mm	Colour: white Height: 150 / 300 / 610 / 760 / 1200 mm
Model	H60000 H1 = 720 mm H60001 H2 = 870 mm	H60002 H3 = 1220 mm H60003 H5 = 2090 mm H60004 H6 = 2700 mm H60005 H7 = 2850 mm	H60040 W = 310 mm H60041 W = 510 mm H60042 W = 690 mm

Special panels

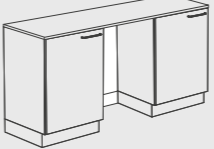
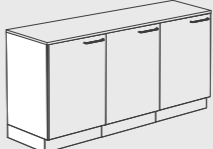
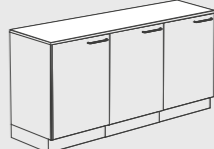
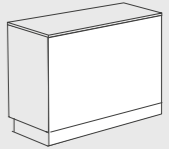
				
Name	Intermediate panel rear	Side panel	Cover plate	Visible rear wall
Description	Intermediate panel for base cabinet, incl. anthracite plinth, panelling flush with carcass, incl. assembly material	Side panel for base cabinet, incl. anthracite plinth, panelling flush with carcass, incl. assembly material	Cover plate for cabinets, incl. assembly material	Visible rear wall for cabinets, incl. anthracite plinth, panelling flush with carcass, incl. assembly material
Versions	Colour: white Width: 600 / 900 / 1200 mm	Colour: white Width: 635 / 710 / 785 mm	Colour: white / oak Width: 600 / 900 / 1050 / 1200 / 1350 / 1500 / 1650 / 1800 / 1950 / 2100 / 2250 / 2400 mm	Colour: white Width: 450 / 600 / 900 / 1200 mm
Model	H60050 H1 = 720 mm H60051 H2 = 870 mm	H60060 H1 = 720 mm H60061 H2 = 870 mm	H60090 D = 380 mm H60091 D = 400 mm H60092 D = 580 mm H60093 D = 600 mm	H60080 H1 = 720 mm H60081 H2 = 870 mm H60082 H3 = 1220 mm H60083 H5 = 2090 mm

Cabinet accessories

Shelves

For various cabinet types (without installation, supplied loose, load-bearing capacity 30 kg)

				
Name	FB Base cabinet	FB Mobile base cabinet	FB Suspended base cabinet	FB Wall-mounted cabinet
Description	19 mm shelf, incl. 4 shelf clips, from width 845 mm with aluminium reinforcement rail	19 mm shelf, incl. 4 shelf clips, from width 845 mm with aluminium reinforcement rail	19 mm shelf, incl. 4 shelf clips, from width 845 mm with aluminium reinforcement rail	19 mm shelf, incl. 4 shelf clips, from width 845 mm with aluminium reinforcement rail
Versions	Type: base cabinet Width: 450 / 600 / 900 / 1200 mm Depth: 350 / 550 / 650 mm	Type: mobile base cabinet Width: 450 / 545 / 600 / 845 / 900 / 1145 / 1200 mm Depth: 550 mm	Type: suspended base cabinet Width: 450 / 545 / 600 / 845 / 900 / 1145 / 1200 mm Depth: 550 mm	Type: standard wall-mounted cabinet / glass horizontal sash Width: 450 / 600 / 900 / 1200 mm Depth: 350 mm
Model	H15110	H15111	H15112	H15113

				
Name	FB Tall cabinet	FB Top-mounted cabinet	FB Collection cabinet	FB for toxic substances compartment
Description	19 mm shelf, incl. 4 shelf clips, with aluminium reinforcement rail over a width of 845 mm	19 mm shelf, incl. 4 shelf clips, with aluminium reinforcement rail over a width of 845 mm	19 mm shelf, incl. 4 shelf clips, with aluminium reinforcement rail over a width of 845 mm	19 mm shelf, incl. 4 shelf clips
Versions	Type: tall cabinet / tall cabinet with partition panel / wardrobe / sliding door cabinet / acid and alkali cabinet (incl. PP tray) / garage cabinet Width: depends on type Depth: depends on type	Type: top-mounted cabinet with / without ladder rail, with / without exhaust air Width: 450 / 600 / 900 / 1200 mm Depth: 350 / 550 mm	Type: collection cabinet Width: 600 / 1200 mm Depth: 550 / 1100 mm	Type: cabinet for chemicals with compartment for toxic substances Width: 600 mm Depth: 550 mm
Model	H15114	H15115	H15117	H15118

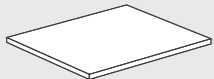
	
Name	FB Pigeon hole/locker cabinet
Description	19 mm shelf, incl. 4 shelf clips
Versions	Type: pigeon hole / pigeon hole and locker cabinet Width: 600 mm Depth: 350 / 550 mm
Model	H15119



Shelf with reinforcement rail made from anodised aluminium (from width 845 mm)

Pull-out shelves

For various cabinet types (with installation, installation position required, load-bearing capacity 30 kg)

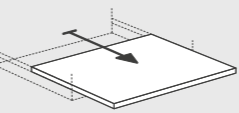
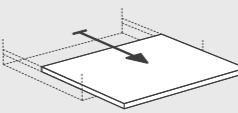
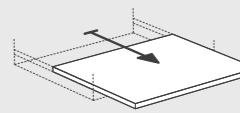
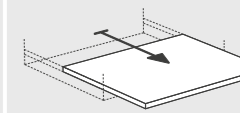
				
Name	Pull-out shelf for base cabinet	Pull-out shelf for mobile base cabinet	Pull-out shelf for suspended base cabinet	Pull-out shelf for tall cabinet
Description	19 mm shelf, from width 845 mm with aluminium reinforcement rail	19 mm shelf, from width 845 mm with aluminium reinforcement rail	19 mm shelf, from width 845 mm with aluminium reinforcement rail	19 mm shelf, from width 845 mm with aluminium reinforcement rail
Versions	Type: base cabinet Width: 450 / 600 / 900 / 1200 mm Depth: 550 / 650 mm	Type: mobile base cabinet Width: 450 / 545 / 600 / 845 / 900 / 1145 / 1200 mm Depth: 550 mm	Type: suspended base cabinet Width: 450 / 545 / 600 / 845 / 900 / 1145 / 1200 mm Depth: 550 mm	Type: tall cabinet / tall cabinet with partition panel / wardrobe / sliding door cabinet / acid and alkali cabinet (incl. PP tray) / garage cabinet Width: depends on type Depth: depends on type
Model	H15102	H15103	H15104	H15106



Pull-out shelf with PP tray

Interior drawers

For various cabinet types (with installation, installation position required, load-bearing capacity 30 kg)

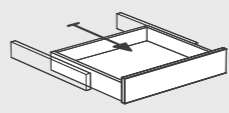
	
Name	Interior Drawer
Description	Drawer with full extension for installation in existing cabinets, colour: white
Model	H15150 W = 600 mm
	H15151 W = 900 mm
	H15152 W = 1200 mm
	H15153 W = 1200 mm, middle wall



Available to order soon

Cabinet accessories

Stepped inserts + glass tops

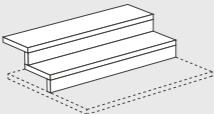
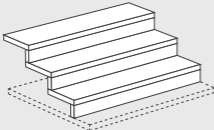
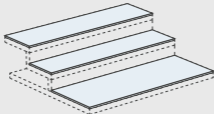
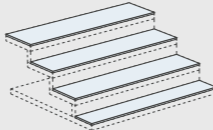

				
Name	Stepped insert 2-steps	Stepped insert 3-steps	Glass top 2-steps	Glass top 3-steps
Description	Stepped insert for installation on existing shelves, colour: white Step 1: H/D = 64/127 mm Step 2: H/D = 64/146 mm	Stepped insert for installation on existing shelves, colour: white Step 1: H/D = 64/127 mm Step 2: H/D = 64/127 mm Step 3: H/D = 64/146 mm	Glass tops for stepped insert, float glass d = 6 mm Step 0: D = 215 mm Step 1: D = 126 mm Step 2: D = 146 mm	Glass tops for stepped insert, float glass d = 6 mm Step 0: D = 91 mm Step 1: D = 126 mm Step 2: D = 126 mm Step 3: D = 146 mm
Model	H15120 W = 600 mm H15121 W = 900 mm H15122 W = 1200 mm	H15123 W = 600 mm H15124 W = 900 mm H15125 W = 1200 mm	H15140 W = 600 mm H15141 W = 900 mm H15142 W = 1200 mm	H15143 W = 600 mm H15144 W = 900 mm H15145 W = 1200 mm

		
Name	Glass top 350	Glass top 550
Description	Glass tops for shelf, float glass d = 6 mm, D = 288 mm	Glass tops for shelf, float glass d = 6 mm, D = 488 mm
Model	H15130 W = 600 mm H15131 W = 900 mm H15132 W = 1200 mm H15133 W = 1200 mm, middle wall	H15134 W = 600 mm H15135 W = 900 mm H15136 W = 1200 mm H15137 W = 1200 mm, middle wall

Drawer insert trays

For drawer widths 450–600 mm

				
Name	Insert tray for 450 mm	Insert tray for 545 mm	Insert tray for 600 mm	Insert tray for 600 mm
Description	Flexible division, plastic PP, colour white, surface grained, aluminium profile rail	Flexible division, plastic PP, colour white, surface grained, aluminium profile rail	Flexible division, plastic PP, colour white, surface grained, aluminium profile rail	Flexible division, plastic PP, colour white, surface grained, aluminium profile rail
Dimensions	W/H/D = 350/48/480 mm	W/H/D = 445/48/480 mm	W/H/D = 500/48/480 mm	W/H/D = 500/48/480 mm
Model	H51200	H51201	H51202	H51203

For drawer widths 845–900 mm

				
Name	Insert tray for 845 mm	Insert tray for 900 mm	Insert tray for 900 mm	Insert tray for 900 mm
Description	Flexible division, plastic PP, colour white, surface grained, aluminium profile rail	Flexible division, plastic PP, colour white, surface grained, aluminium profile rail	Flexible division, plastic PP, colour white, surface grained, aluminium profile rail	Flexible division, plastic PP, colour white, surface grained, aluminium profile rail
Dimensions	W/H/D = 745/48/480 mm	W/H/D = 800/48/480 mm	W/H/D = 800/48/480 mm	W/H/D = 800/48/480 mm
Model	H51204	H51205	H51206	H51207

For drawer widths 1145–1200 mm

				
Name	Insert tray for 1145 mm	Insert tray for 1145 mm	Insert tray for 1200 mm	Insert tray for 1200 mm
Description	Flexible division, plastic PP, colour white, surface grained, aluminium profile rail	Flexible division, plastic PP, colour white, surface grained, aluminium profile rail	Flexible division, plastic PP, colour white, surface grained, aluminium profile rail	Flexible division, plastic PP, colour white, surface grained, aluminium profile rail
Dimensions	W/H/D = 1045/48/480 mm	W/H/D = 1045/48/480 mm	W/H/D = 1100/48/480 mm	W/H/D = 1100/48/480 mm
Model	H51208	H51209	H51210	H51211

Cabinet accessories

Drawer inserts

		
Name	Compartment divider	Suspension file rack insert
Description	Compartment divider made from solid core material, consisting of 2 lateral and 2 longitudinal dividers	Suspension file rack insert made from plastic, colour grey, for drawer height from 350 mm
Dimensions	H = 70 mm	W/H/D = 350/246/350 mm
Model	H51220 W = 450 mm	H51233
	H51221 W = 545 mm	
	H51222 W = 600 mm	
	H51223 W = 845 mm	
	H51224 W = 900 mm	
	H51225 W = 1145 mm	
	H51226 W = 1200 mm	

Waste bin

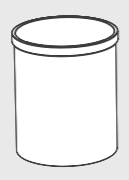
		
Name	Built-in waste bin	Waste paper basket 30
Description	Built-in waste bin, half-round for installation on the inside of the door, lid opens automatically when the door is opened, white plastic Installation height: at least 340 mm	Waste paper basket, material polyethylene, capacity 30 litres
Dimensions	W/H/D = 345/287/240 mm	W/H/D = 350/410/350 mm
Model	9524	9421

Safes

			
Name	Wall safe	Cabinet for toxic substances made from steel plate	Furniture safe
Description	Wall safe for storing protected radioactive preparations	Cabinet for toxic substances made from steel plate, stove-enamelled light grey, separate lockable poison compartment, 1 adjustable sheet metal shelf	Furniture insert safe, security level B acc. VDMA 24992, colour light grey RAL 7035, with 2 holes in the rear wall, double-bit lock
Dimensions	W/H/D = 310/350/150 mm	W/H/D = 455/555/175 mm	W/H/D = 355/425/395 mm
Model	9751	9050	9990

Wardrobes

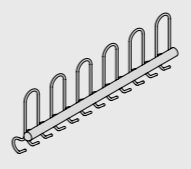
	
Name	Wardrobe rail
Description	Wall-mounted wardrobe rail, powder-coated steel tube incl. wall spacer, 3x steel hooks sintered black, hook spacing 200 mm
Versions	Width: 1 / 2 / 3 / 4 / 5 m
Options	Termination left: curve / hemisphere Termination right: curve / hemisphere
Model	8300 silver
	8301 coated in ME01



 Can be ordered on request

Cabinet accessories



Underfit lamps

Name	Underfit lamp LED	Connection cable
Description	LED underfit lamp with switch and row linking, gap-free strip lights (max. 300 W), anodised aluminium housing with plastic diffusing lens, light colour: approx. 4000 K, illuminant: 80 lm/W, colour reproduction: Ra/CRI > 80, service life: approx. 30,000 hours Connection: 220 – 240 V / 50 – 60 Hz,	Connection cable, suitable for LED underfit lamp
Dimensions	H/D = 15/40 mm	L = 2000 mm
Model	H15190 W = 600 mm / 10 W H15191 W = 900 mm / 15 W H15192 W = 1200 mm / 18 W H15193 W = 1500 mm / 22 W H15194 W = 1800 mm / 27 W	H15195 Euro plug H15196 Wire end ferrules



Ladders & Steps

Name	Single ladder	Parking rail for single ladder
Description	Aluminium single step ladder, with 2 pairs of suspension hooks, load-bearing capacity = 150 kg	Mount for storing the single step ladder for installation at the side of the cabinet or wall, wooden panel incl. 2 stainless steel bow-type handles
Dimensions	W/H = 450/2330 mm	W/H/D = 500/120/50 mm
Model	H9655	H9656

Name	Light metal ladder Alu	Hinged step Alu	Plastic rolling step
Description	Light metal step ladder made from polished aluminium, non-slip treads, 3 steps and 1 hinged step	Hinged step made from polished aluminium, 2 steps on each side	Rolling step made from grey plastic, top diameter 283 mm, bottom diameter 433 mm
Dimensions		H = 460 mm	H = 410 mm
Model	9730	9731	9732

Mounts

Name	Wall bracket for measurement lines	Wall bracket for support rods
Description	Wall bracket for measurement lines, colour: light grey	Wall bracket for 16 support rods, consisting of holding rail above and below
Dimensions	W = 500 mm	W/H/D = 500/50/42 mm
Model	5107	5105

 Can be ordered on request

Product range

- School equipment
- Scientific equipment
- Equipment for further education and training

Services

- Consultation & Planning
- Production & Installation
- Service & Maintenance

HOHENLOHER

International Business

Hohenloher Spezialmöbelwerk
Schaffitzel GmbH + Co. KG

Anton-Waldner-Str. 10-16
88239 Wangen im Allgäu · Germany

Tel: + 49 (0) 7522 / 986 - 504
Fax: + 49 (0) 7522 / 986 - 526

ib@hohenloher.de
www.hohenloher.com